



He Kaupare. He Manaaki.  
He Whakaora.  
prevention. care. recovery.



# ACC List Equipment

- Simple [\(Pages 2 - 44\)](#)
- Standard [\(Pages 45 - 58\)](#)
- Complex [\(Pages 59 - 76\)](#)



**Version: 31**  
**Issued: 16/04/2024**

# ACC

# Simple List Equipment

## Similar item

Similar drop down option will be available for selection if the similar item is in the warehouse for dispatch.

## Table of Contents

Ambulatory	3
Bedroom	7
Kitchen & Living	11
Manual Handling	18
Office	20
Shower & Bath	27
Toileting	34
Wheelchairs & Seating	38
Daily Living Aids	40

# ACC Simple List Equipment

## Ambulatory

Walking Frame - Light Weight				Simple
		<b>SPECIFICATIONS</b>		
		Folding Lightweight aluminium Suitable for indoor use only  610mm overall width 790-920mm adjustable height		
<b>SUPPLIER/BRAND</b>		<b>MAX USER WEIGHT</b>		
Tubular Equipment		160kg		
SUPPLIER PRODUCT ID	ENZ LIST CODE	SPECIFICATIONS	ACC SIC CODE	
AF1101	ENZA118	4 Stoppers	EM042	
AF1103G	ENZA192	Front castors / rear glide feet	EM043	
AF1102G	ENZA135	Front wheels / rear glide feet	EM044	
AF1103	ENZA137	Front castors / rear stoppers	EM045	
AF1102	ENZA126	Front wheels / rear stoppers	EM046	
ACCESSORIES				
DESCRIPTION	ENZ LIST CODE	SUPPLIER PRODUCT ID	ACC SIC CODE	
Basket/tray	ENZA110	BSKT88	EM047	

Walking Frame - Standard				Simple
		<b>SPECIFICATIONS</b>		
		Pacer Front castors / rear wheels and Handbrake Folding Standard with basket and tray Suitable for indoor use only  570mm overall width 755-990mm adjustable handle height		
<b>SUPPLIER/BRAND</b>		<b>MAX USER WEIGHT</b>		
Cubro/Pacer		160kg		
SUPPLIER PRODUCT ID	ENZ LIST CODE	ACC SIC CODE		
1875HB	ENZA127	EM039		

# ACC Simple List Equipment

## Ambulatory

Walking Frame - Rollator			Simple
		<b>SPECIFICATIONS</b>	
		Super Stroller Narrow Folding Standard with bag Suitable for indoor use only  500mm overall width 750-880mm adjustable handle height 150mm (6 inch) Castor and rear wheel	
<b>SUPPLIER/BRAND</b>		<b>MAX USER WEIGHT</b>	
Cubro/Super Stroller		127kg	
<b>SUPPLIER PRODUCT ID</b>	<b>ENZ LIST CODE</b>	<b>ACC SIC CODE</b>	
1845	ENZA112	EM037	
ACCESSORIES			
<b>DESCRIPTION</b>	<b>ENZ LIST CODE</b>	<b>SUPPLIER PRODUCT ID</b>	<b>ACC SIC CODE</b>
Tray	ENZA50	1944	EM049

Walking Frame - Rollator			Simple
		<b>SPECIFICATIONS</b>	
		Lightweight aluminium Height adjustable seat Standard with bag Suitable for indoor & outdoor use.  8" wheels 590mm overall width 545-620mm adjustable seat height 850-1010mm adjustable handle height	
<b>SUPPLIER/BRAND</b>		<b>MAX USER WEIGHT</b>	
Independent Living Service		136kg	
<b>SUPPLIER PRODUCT ID</b>	<b>ENZ LIST CODE</b>	<b>ACC SIC CODE</b>	
ILS-9288-8	ENZA105	EM035	
ACCESSORIES			
<b>DESCRIPTION</b>	<b>ENZ LIST CODE</b>	<b>SUPPLIER PRODUCT ID</b>	<b>ACC SIC CODE</b>
Tray	ENZA31	ILS-9288-TR	EM048

# ACC Simple List Equipment

## Ambulatory

Walking Frame - Gutter			Simple
		<b>SPECIFICATIONS</b>	
		Adjustable forearm support Front castors / rear wheels and Handbrake Suitable for indoor use only  475mm overall width 800-1250mm adjustable handle height 150mm (6 inch) Castor and wheels	
<b>SUPPLIER/BRAND</b>		<b>MAX USER WEIGHT</b>	
Cubro/Pacer		160kg	
<b>SUPPLIER PRODUCT ID</b>	<b>ENZ LIST CODE</b>	<b>ACC SIC CODE</b>	
1905HB	ENZA180	EM029	

Walking Stick			Simple
		<b>SPECIFICATIONS</b>	
		Crook handle  760-995mm adjustable height	
<b>SUPPLIER/BRAND</b>		<b>MAX USER WEIGHT</b>	
Cubro/Mobilis		127kg	
<b>SUPPLIER PRODUCT ID</b>	<b>ENZ LIST CODE</b>	<b>ACC SIC CODE</b>	
1704BL	ENZA21	EM040	

Walking Stick			Simple
		<b>SPECIFICATIONS</b>	
		Swan handle  780-1016mm adjustable height	
<b>SUPPLIER/BRAND</b>		<b>MAX USER WEIGHT</b>	
Allied Medical Ltd		125kg	
<b>SUPPLIER PRODUCT ID</b>	<b>ENZ LIST CODE</b>	<b>ACC SIC CODE</b>	
MP10602B	ENZA17	EM041	

# ACC Simple List Equipment

## Ambulatory

Elbow Crutch			Simple
		<b>SPECIFICATIONS</b>	
		Double adjustable (Pair) Comfy Handle  630mm-860mm adjustable height handle to floor 240mmx320mm adjustable height handle to top of cuff	
<b>SUPPLIER/BRAND</b>		<b>MAX USER WEIGHT</b>	
Allied Medical Ltd		115kg	
<b>SUPPLIER PRODUCT ID</b>	<b>ENZ LIST CODE</b>	<b>ACC SIC CODE</b>	
MP10403	ENZA24	EM001	

Elbow Crutch			Simple
		<b>SPECIFICATIONS</b>	
		Double adjustable (Pair)  200-270mm adjustable height armband to grip 670-920mm adjustable height handgrip to ground	
<b>SUPPLIER/BRAND</b>		<b>MAX USER WEIGHT</b>	
Cubro/Coopers		180kg	
<b>SUPPLIER PRODUCT ID</b>	<b>ENZ LIST CODE</b>	<b>ACC SIC CODE</b>	
1742	ENZA25	EM002	

Knee Walker			Simple
		<b>SPECIFICATIONS</b>	
		Knee Walker Basket Handle & Crutch holder set with mounting hardware  Height:Max 500mm Height Min: 790mm	
<b>SUPPLIER/BRAND</b>		<b>MAX USER WEIGHT</b>	
Cubro/Freiheit		130kg	
<b>SUPPLIER PRODUCT ID</b>	<b>ENZ LIST CODE</b>	<b>ACC SIC CODE</b>	
1549	ENZA142	EM005	

# ACC Simple List Equipment

## Bedroom

Backrest			Simple
		<b>SPECIFICATIONS</b>	
		Standard single webbed  610mm width 510mm depth 25-65 degree angle position	
<b>SUPPLIER/BRAND</b>		<b>MAX USER WEIGHT</b>	
Allied Medical Ltd		100kg	
<b>SUPPLIER PRODUCT ID</b>	<b>ENZ LIST CODE</b>	<b>ACC SIC CODE</b>	
MP30101	ENZA30	EC001	

Bed Cradle			Simple
		<b>SPECIFICATIONS</b>	
		Blanket cradle for bed  320 overall width 500mm overall length 600mm overall height	
<b>SUPPLIER/BRAND</b>		<b>MAX USER WEIGHT</b>	
Cubro/Viking		N/A	
<b>SUPPLIER PRODUCT ID</b>	<b>ENZ LIST CODE</b>	<b>ACC SIC CODE</b>	
283	ENZA29	EC010	

Bed Lever			Simple
		<b>SPECIFICATIONS</b>	
		Bed Lever flat bottom with anti-entrapment bar, cord and cleat wood base  550mm Loop height 800mm Board length 290mm Width of board	
<b>SUPPLIER/BRAND</b>		<b>MAX USER WEIGHT</b>	
Tastech Services Ltd		150kg	
<b>SUPPLIER PRODUCT ID</b>	<b>ENZ LIST CODE</b>	<b>ACC SIC CODE</b>	
BLF3	ENZA292	EC023	

# ACC Simple List Equipment

## Bedroom

Overbed pole			Simple
	<b>SPECIFICATIONS</b>		
	Freestanding over bed pole  1785mm height 885mm min handle height		
<b>SUPPLIER/BRAND</b>		<b>MAX USER WEIGHT</b>	
Superquip		120kg	
<b>SUPPLIER PRODUCT ID</b>	<b>ENZ LIST CODE</b>	<b>ACC SIC CODE</b>	
070	ENZA117	EC041	

Overbed/chair Table			Simple
	<b>SPECIFICATIONS</b>		
	Tilt Top U Base  450x750mm top size 600-960mm adjustable height		
<b>SUPPLIER/BRAND</b>		<b>MAX USER WEIGHT</b>	
Cubro/Viking		N/A	
<b>SUPPLIER PRODUCT ID</b>	<b>ENZ LIST CODE</b>	<b>ACC SIC CODE</b>	
575	ENZA101	EC050	



# ACC Simple List Equipment

## Bedroom

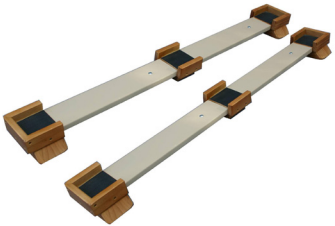
Bed Raiser			Simple
		<b>SPECIFICATIONS</b>	
		Double bed raiser Set of 2 Suits all sizes of double beds that have legs or glides or castor wheels  90x90mm foot pad 150-1700mm adjustable width Standard double to Superking size	
<b>SUPPLIER/BRAND</b>		<b>MAX USER WEIGHT</b>	
Multifit Hospital Supplies		380kg	
SUPPLIER PRODUCT ID	ENZ LIST CODE	HEIGHT	ACC SIC CODE
MF2/4-50/2	ENZA128	50mm	EC062
MF2/4-75/2	ENZA129	75mm	EC063
MF2/4-100/2	ENZA125	100mm	EC060
MF2/4-150/2	ENZA130	150mm	EC064

Bed Raiser			Simple
		<b>SPECIFICATIONS</b>	
		Single Bed troughs Set of 2 Suits single beds that have legs or glides or castor wheels  90x90mm foot pad 815-1100mm adjustable width	
<b>SUPPLIER/BRAND</b>		<b>MAX USER WEIGHT</b>	
Multifit Hospital Supplies		380kg	
SUPPLIER PRODUCT ID	ENZ LIST CODE	HEIGHT	ACC SIC CODE
MF2/2-50/2	ENZA120	50mm	EC065
MF2/2-75/2	ENZA121	75mm	EC066
MF2/2-100/2	ENZA119	100mm	EC061
MF2/2-150/2	ENZA122	150mm	EC067

# ACC Simple List Equipment

## Kitchen & Living

Perching Stool with Arms			Simple
		<b>SPECIFICATIONS</b>	
		Adjustable height With Arms and Back  320mm seat width 885mm min handle height	
<b>SUPPLIER/BRAND</b>		<b>MAX USER WEIGHT</b>	
Allied Medical Ltd		113kg	
<b>SUPPLIER PRODUCT ID</b>	<b>ENZ LIST CODE</b>	<b>ACC SIC CODE</b>	
AML3035	ENZA57	EK040	

Perching Stool without Arms			Simple
		<b>SPECIFICATIONS</b>	
		Adjustable height Without Arms and back  510x420mm Seat 560-700mm Adjustable height	
<b>SUPPLIER/BRAND</b>		<b>MAX USER WEIGHT</b>	
Allied Medical Ltd		125kg	
<b>SUPPLIER PRODUCT ID</b>	<b>ENZ LIST CODE</b>	<b>ACC SIC CODE</b>	
MP30304	ENZA44	EK041	

Perching Stool without Arms			Simple
		<b>SPECIFICATIONS</b>	
		Adjustable height Without arms, with back  330x310 Seat 550mmx700mm Adjustable height	
<b>SUPPLIER/BRAND</b>		<b>MAX USER WEIGHT</b>	
Cubro/Viking		120kg	
<b>SUPPLIER PRODUCT ID</b>	<b>ENZ LIST CODE</b>	<b>ACC SIC CODE</b>	
746	ENZA96	EK043	

# ACC Simple List Equipment

## Kitchen & Living

Utility Chair			Simple
		<b>SPECIFICATIONS</b>	
		Rehab chair Multi purpose  430 - 580mm adjustable height 440mm width between arms 430mm seat width 440mm seat depth	
<b>SUPPLIER/BRAND</b>		<b>MAX USER WEIGHT</b>	
Cubro/Viking		200kg	
<b>SUPPLIER PRODUCT ID</b>	<b>ENZ LIST CODE</b>	<b>ACC SIC CODE</b>	
609S	ENZA116	EK060	

Utility Chair			Simple
		<b>SPECIFICATIONS</b>	
		Hilite chair Multit purpose  550 - 400mm adjustable height 520mm width between arms 520mm seat width 480-520 seat depth adjustable	
<b>SUPPLIER/BRAND</b>		<b>MAX USER WEIGHT</b>	
Cubro/Viking		200kg	
<b>SUPPLIER PRODUCT ID</b>	<b>ENZ LIST CODE</b>	<b>ACC SIC CODE</b>	
610S	ENZA171	EK061	

# ACC Simple List Equipment

## Kitchen & Living

Kitchen Trolley			Simple
		<b>SPECIFICATIONS</b>	
		Kitchen Trolley with handle  430mm width 430mm depth 870mm height	
<b>SUPPLIER/BRAND</b>		<b>MAX WEIGHT - ON TRAY</b>	
Tastech Services Ltd		30kg	
<b>SUPPLIER PRODUCT ID</b>	<b>ENZ LIST CODE</b>	<b>ACC SIC CODE</b>	
RT1H	ENZA84	EK031	

Kitchen Trolley			Simple
		<b>SPECIFICATIONS</b>	
		Kitchen Trolley Adjustable height  430mm width 430mm depth 870mm height	
<b>SUPPLIER/BRAND</b>		<b>MAX WEIGHT - ON TRAY</b>	
Superquip Ltd		30kg	
<b>SUPPLIER PRODUCT ID</b>	<b>ENZ LIST CODE</b>	<b>ACC SIC CODE</b>	
061A	ENZA271	EK032	

Kitchen Trolley			Simple
		<b>SPECIFICATIONS</b>	
		Kitchen Trolley Adjustable Height  465mm width 490mm length 785-935mm adjustable height	
<b>SUPPLIER/BRAND</b>		<b>MAX WEIGHT - ON TRAY</b>	
Cubro/Chevron		10kg	
<b>SUPPLIER PRODUCT ID</b>	<b>ENZ LIST CODE</b>	<b>ACC SIC CODE</b>	
290	ENZA88	EK030	

# ACC Simple List Equipment

## Kitchen & Living

Can Opener			Simple
		<b>SPECIFICATIONS</b>	
		Open all electric can opener	
<b>SUPPLIER/BRAND</b>		<b>MAX USER WEIGHT</b>	
Noel Leeming/Sunbeam		N/A	
<b>SUPPLIER PRODUCT ID</b>	<b>ENZ LIST CODE</b>	<b>ACC SIC CODE</b>	
CA2800	ENZA1	EK020	

Jar Opener			Simple
		<b>SPECIFICATIONS</b>	
		Good Grips Twisting Jar Opener  177mm Length	
<b>SUPPLIER/BRAND</b>		<b>MAX USER WEIGHT</b>	
Allied Medical Ltd		N/A	
<b>SUPPLIER PRODUCT ID</b>	<b>ENZ LIST CODE</b>	<b>ACC SIC CODE</b>	
GG11332200	ENZA11126	EK021	

Cutlery			Simple
		<b>SPECIFICATIONS</b>	
		Supergrip bendable set of 4	
<b>SUPPLIER/BRAND</b>		<b>MAX USER WEIGHT</b>	
AT Therapy Ltd		N/A	
<b>SUPPLIER PRODUCT ID</b>	<b>ENZ LIST CODE</b>	<b>ACC SIC CODE</b>	
PAT-A703209	ENZA38	EK023	

# ACC Simple List Equipment

## Kitchen & Living

Kettle Tipper			Simple
		<b>SPECIFICATIONS</b>	
		Kettle Tipper Cordless	
<b>SUPPLIER/BRAND</b>		<b>MAX USER WEIGHT</b>	
At Therapy Ltd/Homecraft		N/A	
<b>SUPPLIER PRODUCT ID</b>	<b>ENZ LIST CODE</b>	<b>ACC SIC CODE</b>	
ATUK-091207281	ENZA46	EK026	

Preparation Board			Simple
		<b>SPECIFICATIONS</b>	
		Spreading Board plastic 256x181mm	
<b>SUPPLIER/BRAND</b>		<b>MAX USER WEIGHT</b>	
At Therapy Ltd/Homecraft		N/A	
<b>SUPPLIER PRODUCT ID</b>	<b>ENZ LIST CODE</b>	<b>ACC SIC CODE</b>	
PAT-AA5284	ENZA283	EK070	

Preparation Board			Simple
		<b>SPECIFICATIONS</b>	
		Vegetable spike board 320x300x100mm	
<b>SUPPLIER/BRAND</b>		<b>MAX USER WEIGHT</b>	
Cubro/Etac		N/A	
<b>SUPPLIER PRODUCT ID</b>	<b>ENZ LIST CODE</b>	<b>ACC SIC CODE</b>	
5460	ENZA291	EK071	

# ACC Simple List Equipment

## Kitchen & Living

Preparation Board			Simple
		<b>SPECIFICATIONS</b>	
		Vegetable spike board Small Plastic  140x140x100mm	
<b>SUPPLIER/BRAND</b>		<b>MAX USER WEIGHT</b>	
TasTech Services Ltd		N/A	
<b>SUPPLIER PRODUCT ID</b>	<b>ENZ LIST CODE</b>	<b>ACC SIC CODE</b>	
VH1	ENZA284	EK072	

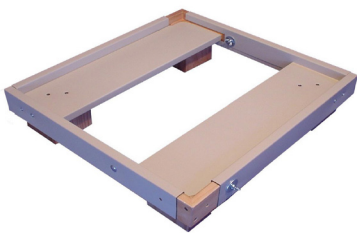
Chair Platform Raiser				Simple
		<b>SPECIFICATIONS</b>		
		Standard Chair Suits most square shape lounge chairs  438-816mm adjustable width 528-873mm adjustable length		
<b>SUPPLIER/BRAND</b>		<b>MAX USER WEIGHT</b>		
Multifit Hospital Supplies		380kg over 4 feet		
<b>SUPPLIER PRODUCT ID</b>	<b>ENZ LIST CODE</b>	<b>HEIGHT</b>	<b>ACC SIC CODE</b>	
MF 1/1-50	ENZA108	50mm	EK003	
MF 1/1-75	ENZA109	75mm	EK004	
MF 1/1-100	ENZA106	100mm	EK001	
MF 1/1-150	ENZA107	150mm	EK002	

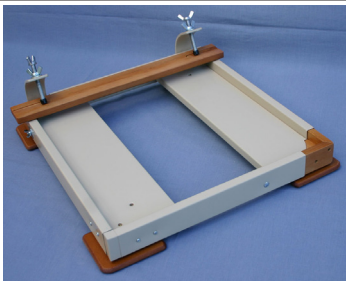
Chair Platform Raiser				Simple
		<b>SPECIFICATIONS</b>		
		Lazy Boy Style Suits LazyBoy style chair which have wooden runners that extend past the rear of the chair base  485-710mm adjustable width 530-885mm adjustable length		
<b>SUPPLIER/BRAND</b>		<b>MAX USER WEIGHT</b>		
Multifit Hospital Supplies		380kg over 4 feet		
<b>SUPPLIER PRODUCT ID</b>	<b>ENZ LIST CODE</b>	<b>HEIGHT</b>	<b>ACC SIC CODE</b>	
MF 1/3-50	ENZA140	50mm	EK007	
MF 1/3-75	ENZA141	75mm	EK008	
MF 1/3-100	ENZA138	100mm	EK005	
MF 1/3-150	ENZA139	150mm	EK006	

# ACC Simple List Equipment

## Kitchen & Living

Raiser				Simple
			<b>SPECIFICATIONS</b>	
			Elephant Feet set of 4	
<b>SUPPLIER/BRAND</b>			<b>MAX USER WEIGHT</b>	
Cubro/Derby			100kg per foot	
SUPPLIER PRODUCT ID	ENZ LIST CODE	HEIGHT	ACC SIC CODE	
181/4	ENZA40	90mm	EK013	
182/4	ENZA45	140mm	EK012	

Chair/Bed Blocks				Simple
			<b>SPECIFICATIONS</b>	
			Chair/Bed Blocks wooden (each)	
<b>SUPPLIER/BRAND</b>			<b>MAX USER WEIGHT</b>	
Multifit Hospital Supplies			100kg per foot	
SUPPLIER PRODUCT ID	ENZ LIST CODE	HEIGHT	ACC SIC CODE	
MF 0/1	ENZA35	50mm	EK010	
MF 0/2	ENZA36	75mm	EK011	
MF 0/3	ENZA34	100mm	EK009	
MF 0/4	ENZA37	150mm	EK014	



# ACC Simple List Equipment

## Manual Handling

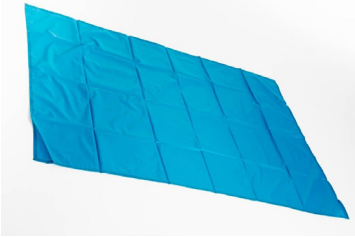
Slide Sheets			Simple
		<b>SPECIFICATIONS</b>	
		Slide Sheet 1metre x 1.5metres	
<b>SUPPLIER/BRAND</b>		<b>MAX USER WEIGHT</b>	
Multifit Hospital Supplies		N/A	
<b>SUPPLIER PRODUCT ID</b>	<b>ENZ LIST CODE</b>	<b>ACC SIC CODE</b>	
MF SS_AMS 1	ENZA26	EH002	

Slide Sheets			Simple
		<b>SPECIFICATIONS</b>	
		Slide Sheet 1100x1500mm	
<b>SUPPLIER/BRAND</b>		<b>MAX USER WEIGHT</b>	
Cubro/Softech		N/A	
<b>SUPPLIER PRODUCT ID</b>	<b>ENZ LIST CODE</b>	<b>ACC SIC CODE</b>	
195	ENZA27	EH001	

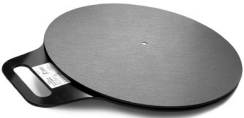
Turntable			Simple
		<b>SPECIFICATIONS</b>	
		RoMedic Turntable 38cm 380mm Diameter	
<b>SUPPLIER/BRAND</b>		<b>MAX USER WEIGHT</b>	
USL Medical/RoMedic		135kg	
<b>SUPPLIER PRODUCT ID</b>	<b>ENZ LIST CODE</b>	<b>ACC SIC CODE</b>	
5085	ENZA97	EH011	

# ACC Simple List Equipment

## Manual Handling

Transfer Belt				Simple
		<b>SPECIFICATIONS</b>		
		Romedic FlexiBelt Hug  Waist Measurement Small- 60-100cm Medium - 70-120cm Large - 100cm-160cm		
<b>SUPPLIER/BRAND</b>		<b>MAX USER WEIGHT</b>		
USL Medical/RoMedic		170kg		
SUPPLIER PRODUCT ID	ENZ LIST CODE	HEIGHT	ACC SIC CODE	
6073	ENZA81	Small	EH012	
6074	ENZA103	Medium	EH013	
6075	ENZA90	Large	EH014	

Transfer Board				Simple
		<b>SPECIFICATIONS</b>		
		Plastic construction Curved board  660mm long 200mm wide		
<b>SUPPLIER/BRAND</b>		<b>MAX USER WEIGHT</b>		
TasTech Services Ltd		110kg		
SUPPLIER PRODUCT ID	ENZ LIST CODE	ACC SIC CODE		
TBP2	ENZA60	EM021		

# ACC Simple List Equipment

## Office

Copy Holder			Simple
		<b>SPECIFICATIONS</b>	
		Gooduse Microdesk  560mm wide 310mm deep	
<b>SUPPLIER/BRAND</b>		<b>MAX USER WEIGHT</b>	
Bytes & Pieces Ltd		N/A	
<b>SUPPLIER PRODUCT ID</b>	<b>ENZ LIST CODE</b>	<b>ACC SIC CODE</b>	
GU-01	ENZA76	EF030	

Copy Holder			Simple
		<b>SPECIFICATIONS</b>	
		3M Document Holder  450.7x270.9x100.1mm	
<b>SUPPLIER/BRAND</b>		<b>MAX USER WEIGHT</b>	
Bytes & Pieces Ltd		N/A	
<b>SUPPLIER PRODUCT ID</b>	<b>ENZ LIST CODE</b>	<b>ACC SIC CODE</b>	
3MDH640a	ENZA83	EF034	

Whiteboard			Simple
		<b>SPECIFICATIONS</b>	
		Whiteboard with pack of 4 markers  400x600mm	
<b>SUPPLIER/BRAND</b>		<b>MAX USER WEIGHT</b>	
Bytes & Pieces Ltd		N/A	
<b>SUPPLIER PRODUCT ID</b>	<b>ENZ LIST CODE</b>	<b>ACC SIC CODE</b>	
WB-LAC4b	ENZA56	EF031	

# ACC Simple List Equipment

## Office

Foot Stool			Simple
		<b>SPECIFICATIONS</b>	
		Fellowes Footrest 455 x 338 x 97mm	
<b>SUPPLIER/BRAND</b>		<b>MAX USER WEIGHT</b>	
Bytes & Pieces Ltd		N/A	
<b>SUPPLIER PRODUCT ID</b>	<b>ENZ LIST CODE</b>	<b>ACC SIC CODE</b>	
C236295b	ENZA48	EF107	

Leg Rest			Simple
		<b>SPECIFICATIONS</b>	
		Legrest adjustable 400-550mm Adjustable height	
<b>SUPPLIER/BRAND</b>		<b>MAX USER WEIGHT</b>	
Cubro/Viking		100kg	
<b>SUPPLIER PRODUCT ID</b>	<b>ENZ LIST CODE</b>	<b>ACC SIC CODE</b>	
60L-SLATE	ENZA113	EF108	

Foot Stool			Simple
		<b>SPECIFICATIONS</b>	
		Footstool Fluteline Large 450 x 350mm	
<b>SUPPLIER/BRAND</b>		<b>MAX USER WEIGHT</b>	
Bytes & Pieces Ltd		N/A	
<b>SUPPLIER PRODUCT ID</b>	<b>ENZ LIST CODE</b>	<b>ACC SIC CODE</b>	
F-Footstool	ENZA58	EF109	

# ACC Simple List Equipment

## Office

Office Chair			Simple
		<b>SPECIFICATIONS</b>	
		Spectrum 2 Hi back No arms Black  Back 460mm Seat depth 480mm Seat width 470mm	
<b>SUPPLIER/BRAND</b>		<b>MAX USER WEIGHT</b>	
Bytes & Pieces Ltd		140kg	
<b>SUPPLIER PRODUCT ID</b>	<b>ENZ LIST CODE</b>	<b>ACC SIC CODE</b>	
Spec2BK	ENZA170	EF111	

Office Chair			Simple
		<b>SPECIFICATIONS</b>	
		Spectrum 3 Hi back No arms Navy  Back 460mm Seat depth 480mm Seat width 470mm	
<b>SUPPLIER/BRAND</b>		<b>MAX USER WEIGHT</b>	
Bytes & Pieces Ltd		140kg	
<b>SUPPLIER PRODUCT ID</b>	<b>ENZ LIST CODE</b>	<b>ACC SIC CODE</b>	
E-Spec3N	ENZA173	EF112	

Office Chair			Simple
		<b>SPECIFICATIONS</b>	
		Spectrum 2 Hi back Height adjustable arms Navy  Back 460mm Seat depth 480mm Seat width 470mm	
<b>SUPPLIER/BRAND</b>		<b>MAX USER WEIGHT</b>	
Bytes & Pieces Ltd		140kg	
<b>SUPPLIER PRODUCT ID</b>	<b>ENZ LIST CODE</b>	<b>ACC SIC CODE</b>	
E-Spec2HA	ENZA174	EF113	

# ACC Simple List Equipment

## Office

Office Chair			Simple
		<b>SPECIFICATIONS</b>	
		Spectrum 3 Hi back Height adjustable arms Black  Back 460mm Seat depth 480mm Seat width 470mm	
<b>SUPPLIER/BRAND</b>		<b>MAX USER WEIGHT</b>	
Bytes & Pieces Ltd		140kg	
<b>SUPPLIER PRODUCT ID</b>	<b>ENZ LIST CODE</b>	<b>ACC SIC CODE</b>	
Spec3HA	ENZA178	EF114	

Office Seat			Simple
		<b>SPECIFICATIONS</b>	
		Bambach saddle seat  570-750mm adjustable seat height	
<b>SUPPLIER/BRAND</b>		<b>MAX USER WEIGHT</b>	
Bytes & Pieces Ltd		120kg	
<b>SUPPLIER PRODUCT ID</b>	<b>ENZ LIST CODE</b>	<b>ACC SIC CODE</b>	
B-Bamach	ENZA181	EF116	

Office Seat			Simple
		<b>SPECIFICATIONS</b>	
		Buro knee Chair Black  430x250mm knee rest 430x340mm seat 530-650mm adjustable seat height	
<b>SUPPLIER/BRAND</b>		<b>MAX USER WEIGHT</b>	
Bytes & Pieces Ltd		130kg	
<b>SUPPLIER PRODUCT ID</b>	<b>ENZ LIST CODE</b>	<b>ACC SIC CODE</b>	
B-Knee	ENZA147	EF117	

# ACC Simple List Equipment

## Office

Office Seat			Simple
		<b>SPECIFICATIONS</b>	
		Posturite Stool No arms Tilt seat  370mm seat depth 410mm seat height 620-70mm adjustable seat height	
<b>SUPPLIER/BRAND</b>		<b>MAX USER WEIGHT</b>	
Bytes & Pieces Ltd		120kg	
<b>SUPPLIER PRODUCT ID</b>	<b>ENZ LIST CODE</b>	<b>ACC SIC CODE</b>	
B-POS270	ENZA136	EF118	

Computer			Simple
		<b>SPECIFICATIONS</b>	
		Logitech Basic Mouse Wired Optical	
<b>SUPPLIER/BRAND</b>		<b>MAX USER WEIGHT</b>	
Bytes & Pieces Ltd		N/A	
<b>SUPPLIER PRODUCT ID</b>	<b>ENZ LIST CODE</b>	<b>ACC SIC CODE</b>	
USBMOUSE	ENZA20	EG010	

Computer			Simple
		<b>SPECIFICATIONS</b>	
		Logitech K120 USB Wired	
<b>SUPPLIER/BRAND</b>		<b>MAX USER WEIGHT</b>	
Bytes & Pieces Ltd		N/A	
<b>SUPPLIER PRODUCT ID</b>	<b>ENZ LIST CODE</b>	<b>ACC SIC CODE</b>	
LOGITECH K120	ENZA22	EG024	

# ACC Simple List Equipment

## Office

Computer			Simple
		<b>SPECIFICATIONS</b>	
		Microsoft Ergonomic Keyboard Wired	
<b>SUPPLIER/BRAND</b>		<b>MAX USER WEIGHT</b>	
Bytes & Pieces Ltd		N/A	
<b>SUPPLIER PRODUCT ID</b>	<b>ENZ LIST CODE</b>	<b>ACC SIC CODE</b>	
N/A	ENZA61	EG025	

Monitor Stand			Simple
		<b>SPECIFICATIONS</b>	
		Fellowes Premium Monitor Stand  334x340mm Adjustable to 5 heights 64-165mm	
<b>SUPPLIER/BRAND</b>		<b>MAX USER WEIGHT</b>	
Bytes & Pieces Ltd		N/A	
<b>SUPPLIER PRODUCT ID</b>	<b>ENZ LIST CODE</b>	<b>ACC SIC CODE</b>	
C-235001b	ENZA49	EG031	

Laptop Raiser			Simple
		<b>SPECIFICATIONS</b>	
		Fellowes Laptop Raiser  165x384x289mm	
<b>SUPPLIER/BRAND</b>		<b>MAX USER WEIGHT</b>	
Bytes & Pieces Ltd		N/A	
<b>SUPPLIER PRODUCT ID</b>	<b>ENZ LIST CODE</b>	<b>ACC SIC CODE</b>	
C-236840	ENZA41	EG041	



# ACC Simple List Equipment

## Office

Ergorest			Simple
		<b>SPECIFICATIONS</b>	
		Ergorest Forearm Support  235mm max operating span 75mm height adjustment 15-43mm desk thickness	
<b>SUPPLIER/BRAND</b>		<b>MAX LOAD</b>	
Bytes & Pieces Ltd		12kg	
<b>SUPPLIER PRODUCT ID</b>	<b>ENZ LIST CODE</b>	<b>ACC SIC CODE</b>	
SY-Ergorests	ENZA92	EG050	

Wrist Rest			Simple
		<b>SPECIFICATIONS</b>	
		Keyboard supergel wrist rest  460x60.5x20mm	
<b>SUPPLIER/BRAND</b>		<b>MAX USER WEIGHT</b>	
Bytes & Pieces Ltd		N/A	
<b>SUPPLIER PRODUCT ID</b>	<b>ENZ LIST CODE</b>	<b>ACC SIC CODE</b>	
L-MP128	ENZA23	EG051	

Wrist Rest			Simple
		<b>SPECIFICATIONS</b>	
		Fellowes Flex rest  2.54x12.38x8.73cm	
<b>SUPPLIER/BRAND</b>		<b>MAX USER WEIGHT</b>	
Bytes & Pieces Ltd		N/A	
<b>SUPPLIER PRODUCT ID</b>	<b>ENZ LIST CODE</b>	<b>ACC SIC CODE</b>	
C-236439b	ENZA280	EG052	

# ACC Simple List Equipment

## Shower & Bath

Suction Rails			Simple
		<b>SPECIFICATIONS</b>	
		Roth Rail Extendable with safety indicator  560-685mm max length adjustment	
<b>SUPPLIER/BRAND</b>		<b>MAX USER WEIGHT</b>	
Medix 21/Roth		85kg	
<b>SUPPLIER PRODUCT ID</b>	<b>ENZ LIST CODE</b>	<b>ACC SIC CODE</b>	
1400222S	ENZA124	EA010	

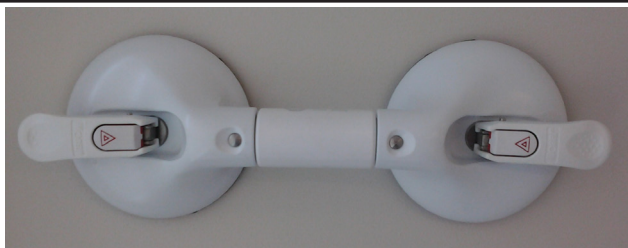
Suction Rails			Simple
		<b>SPECIFICATIONS</b>	
		Roth Rail Short  110mm length	
<b>SUPPLIER/BRAND</b>		<b>MAX USER WEIGHT</b>	
Medix 21/Roth		85kg	
<b>SUPPLIER PRODUCT ID</b>	<b>ENZ LIST CODE</b>	<b>ACC SIC CODE</b>	
1400220S	ENZA85	EA011	

Bath Board			Simple
		<b>SPECIFICATIONS</b>	
		Bath Board - Moulded Plastic  710x290x25mm 25mm max height 480-700mm pillar span	
<b>SUPPLIER/BRAND</b>		<b>MAX USER WEIGHT</b>	
Cubro/Cosby		190kg	
<b>SUPPLIER PRODUCT ID</b>	<b>ENZ LIST CODE</b>	<b>ACC SIC CODE</b>	
243	ENZA288	EB001	

# ACC Simple List Equipment

## Shower & Bath

Bath Board			Simple
		<b>SPECIFICATIONS</b>	
		Bath Board - Moulded Plastic  710x305x68mm 68mm max height 480-630mm pillar span	
<b>SUPPLIER/BRAND</b>		<b>MAX USER WEIGHT</b>	
Cubro/Derby		190kg	
<b>SUPPLIER PRODUCT ID</b>	<b>ENZ LIST CODE</b>	<b>ACC SIC CODE</b>	
257	ENZA77	EB002	

Transfer Bench			Simple
		<b>SPECIFICATIONS</b>	
		Transfer Bench  825-940mm adjustable height 380-490mm bath clearance 845mm width 500mm depth	
<b>SUPPLIER/BRAND</b>		<b>MAX USER WEIGHT</b>	
Cubro/Oakwood		130kg	
<b>SUPPLIER PRODUCT ID</b>	<b>ENZ LIST CODE</b>	<b>ACC SIC CODE</b>	
256	ENZA93	EB020	

Transfer Bench			Simple
		<b>SPECIFICATIONS</b>	
		Transfer Bench Padded  795-910mm adjustable height 350-460mm bath clearance	
<b>SUPPLIER/BRAND</b>		<b>MAX USER WEIGHT</b>	
Cubro/Oakwood		130kg	
<b>SUPPLIER PRODUCT ID</b>	<b>ENZ LIST CODE</b>	<b>ACC SIC CODE</b>	
241	ENZA145	EB113	

# ACC Simple List Equipment

## Shower & Bath

Shower Chair			Simple
		<b>SPECIFICATIONS</b>	
		Shower chair with arms 490mm width between arms 490-640mm adjustable height	
<b>SUPPLIER/BRAND</b>		<b>MAX USER WEIGHT</b>	
Goldfern Mobility		110kg	
<b>SUPPLIER PRODUCT ID</b>	<b>ENZ LIST CODE</b>	<b>ACC SIC CODE</b>	
GM-HMP-792LA	ENZA297	EB045	

Shower Stool			Simple
		<b>SPECIFICATIONS</b>	
		Shower stool without arms 490-610mm adjustable height 285x380mm seat size	
<b>SUPPLIER/BRAND</b>		<b>MAX USER WEIGHT</b>	
Goldfern Mobility		120kg	
<b>SUPPLIER PRODUCT ID</b>	<b>ENZ LIST CODE</b>	<b>ACC SIC CODE</b>	
GM-HMP-792	ENZA43	EB046	

# ACC Simple List Equipment

## Shower & Bath

Shower Stool			Simple
		<b>SPECIFICATIONS</b>	
		Shower stool with arms 470mm width between arms 490-610mm adjustable height	
<b>SUPPLIER/BRAND</b>		<b>MAX USER WEIGHT</b>	
Goldfern Mobility		170kg	
<b>SUPPLIER PRODUCT ID</b>	<b>ENZ LIST CODE</b>	<b>ACC SIC CODE</b>	
GM-HMP-792A	ENZA296	EB044	

Shower Stool			Simple
		<b>SPECIFICATIONS</b>	
		Shower stool with arms - Heavy duty Height adjustable 440-600mm height adjustable 440x360mm seat size 480mm width between arms	
<b>SUPPLIER/BRAND</b>		<b>MAX USER WEIGHT</b>	
Tubular Equipment		200kg	
<b>SUPPLIER PRODUCT ID</b>	<b>ENZ LIST CODE</b>	<b>ACC SIC CODE</b>	
SSHD61	ENZA114	EB043	

# ACC Simple List Equipment

## Shower & Bath

Swivel bather				Simple
		<b>SPECIFICATIONS</b>		
		Swivel bath seat See below for height options  470mm width between arms 700-855mm adjustable base width 420mm back height		
<b>SUPPLIER/BRAND</b>		<b>MAX USER WEIGHT</b>		
Cubro/Oakwood		120kg		
SUPPLIER PRODUCT ID	ENZ LIST CODE	HEIGHT	ACC SIC CODE	
508	ENZA144	Swivel Bather	EB050	
508/HA50	ENZA168	Swivel Bather with 50mm height adaptor	EB051	
508/HA100	ENZA169	Swivel Bather with 100mm height adaptor	EB052	

Shower Attachment				Simple
		<b>SPECIFICATIONS</b>		
		Handheld bath & shower set  150cm Hose length		
<b>SUPPLIER/BRAND</b>		<b>MAX USER WEIGHT</b>		
Cubro/Oakwood		N/A		
SUPPLIER PRODUCT ID	ENZ LIST CODE	ACC SIC CODE		
190	ENZA286	EB030		

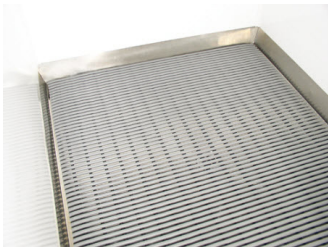
Shower Mat				Simple
		<b>SPECIFICATIONS</b>		
		Shower Matting  900x1000mm		
<b>SUPPLIER/BRAND</b>		<b>MAX USER WEIGHT</b>		
Cubro/Hull		N/A		
SUPPLIER PRODUCT ID	ENZ LIST CODE	ACC SIC CODE		
224	ENZA289	EB061		

# ACC Simple List Equipment

## Shower & Bath

Step		Simple	
		<b>SPECIFICATIONS</b>	
		Bathroom two step 100 or 150 mm step height	
<b>SUPPLIER/BRAND</b>		<b>MAX USER WEIGHT</b>	
Cubro/Ashby		190kg	
<b>SUPPLIER PRODUCT ID</b>	<b>ENZ LIST CODE</b>	<b>ACC SIC CODE</b>	
124	ENZA294	EB070	

Long handled sponge		Simple	
		<b>SPECIFICATIONS</b>	
		Long handled Sponge 550mm length	
<b>SUPPLIER/BRAND</b>		<b>MAX USER WEIGHT</b>	
Cubro		190kg	
<b>SUPPLIER PRODUCT ID</b>	<b>ENZ LIST CODE</b>	<b>ACC SIC CODE</b>	
1088093	ENZA277	EB080	

# ACC Simple List Equipment

## Shower & Bath

Shower Commode			Simple
		<b>SPECIFICATIONS</b>	
		Shower commode attendant propelled Frame only  490mm width between arms <b>Seat not included please select accessories below</b>	
<b>SUPPLIER/BRAND</b>		<b>MAX USER WEIGHT</b>	
Cubro/Juvo Viking		200kg	
<b>SUPPLIER PRODUCT ID</b>	<b>ENZ LIST CODE</b>	<b>ACC SIC CODE</b>	
2346U	ENZA205	EB126	
ACCESSORIES			
DESCRIPTION	ENZ LIST CODE	SUPPLIER PRODUCT ID	ACC SIC CODE
Closed Seat	ENZA79	75PC/75PR-FITTED	EB107
Open Seat	ENZA80	75PO/75PR-FITTED	EB108
Bedpan & carrier	ENZA52	2359/75P	EB105
Bowl w/ lid & Pan carrier	ENZA53	2359/325	EB106

Shower Commode			Simple
		<b>SPECIFICATIONS</b>	
		Shower commode self propelled Frame only  465mm width between arms <b>Seat not included please select accessories below</b>	
<b>SUPPLIER/BRAND</b>		<b>MAX USER WEIGHT</b>	
Cubro/Juvo Viking		200kg	
<b>SUPPLIER PRODUCT ID</b>	<b>ENZ LIST CODE</b>	<b>ACC SIC CODE</b>	
2348U	ENZA211	EB127	
ACCESSORIES			
DESCRIPTION	ENZ LIST CODE	SUPPLIER PRODUCT ID	ACC SIC CODE
Closed Seat	ENZA79	75PC/75PR-FITTED	EB107
Open Seat	ENZA80	75PO/75PR-FITTED	EB108
Bedpan & carrier	ENZA52	2359/75P	EB105
Bowl w/ lid & Pan carrier	ENZA53	2359/325	EB106



# ACC Simple List Equipment



## Toileting

Bed Pan			Simple
		<b>SPECIFICATIONS</b>	
		Bed pan Autoclavable 135°C.	
<b>SUPPLIER/BRAND</b>		<b>MAX USER WEIGHT</b>	
Cubro/Plasbro		N/A	
<b>SUPPLIER PRODUCT ID</b>	<b>ENZ LIST CODE</b>	<b>ACC SIC CODE</b>	
211	ENZA19	ET001	

Bedside commode			Simple
		<b>SPECIFICATIONS</b>	
		Bedside commode 480-600mm adjustable seat height 440mm seat width 440mm seat depth	
<b>SUPPLIER/BRAND</b>		<b>MAX USER WEIGHT</b>	
Cubro/Viking		120kg	
<b>SUPPLIER PRODUCT ID</b>	<b>ENZ LIST CODE</b>	<b>ACC SIC CODE</b>	
565	ENZA293	ET011	

# ACC Simple List Equipment

## Toileting

3 n 1 Commode			Simple
		SPECIFICATIONS	
		3 in 1 Commode 640mm overall width 450mm overall depth 420-560 Adj floor to seat height	
SUPPLIER/BRAND		MAX USER WEIGHT	
Allied Medical/Maxhealth			
SUPPLIER PRODUCT ID	ENZ LIST CODE	ACC SIC CODE	
AML20505	ENZA1809	ET051	
Toilet Surround			Simple
		SPECIFICATIONS	
		Freestanding toilet frame 675-775mm adjustable height 440-640mm adjustable width	
SUPPLIER/BRAND		MAX USER WEIGHT	
Goldfern Mobility		120kg	
SUPPLIER PRODUCT ID	ENZ LIST CODE	ACC SIC CODE	
GM-HMP-8109	ENZA290	ET014	
ACCESSORIES			
DESCRIPTION	ENZ LIST CODE	SUPPLIER PRODUCT ID	ACC SIC CODE
Suction Feet	ENZA264	GMP-HMP-8109TIP-S	ET016

# ACC Simple List Equipment

## Toileting

Toilet Surround			Simple
		<b>SPECIFICATIONS</b>	
		Freestanding toilet frame Heavy duty  440-640mm adjustable width 675-775mm adjustable height	
<b>SUPPLIER/BRAND</b>		<b>MAX USER WEIGHT</b>	
Goldfern Mobility		200kg	
<b>SUPPLIER PRODUCT ID</b>	<b>ENZ LIST CODE</b>	<b>ACC SIC CODE</b>	
GM-HMP-8109S	ENZA59	ET015	
ACCESSORIES			
<b>DESCRIPTION</b>	<b>ENZ LIST CODE</b>	<b>SUPPLIER PRODUCT ID</b>	<b>ACC SIC CODE</b>
Suction Feet	ENZA16	GMP-HMP-8109TIP-S	ET016

Toilet Frame			Simple
		<b>SPECIFICATIONS</b>	
		Over-toilet frame Supplied with splash guard  480-620mm adjustable height 445mm between arm width	
<b>SUPPLIER/BRAND</b>		<b>MAX USER WEIGHT</b>	
Cubro/Viking		150kg	
<b>SUPPLIER PRODUCT ID</b>	<b>ENZ LIST CODE</b>	<b>ACC SIC CODE</b>	
390	ENZA287	ET030	

Toilet Frame			Simple
		<b>SPECIFICATIONS</b>	
		Over toilet frame heavy duty extra wide seat fixed height  570mm seat height 600mm between arms	
<b>SUPPLIER/BRAND</b>		<b>MAX USER WEIGHT</b>	
Cubro/Viking		300kg	
<b>SUPPLIER PRODUCT ID</b>	<b>ENZ LIST CODE</b>	<b>ACC SIC CODE</b>	
398	ENZA295	ET052	

# ACC Simple List Equipment

## Toileting

Toilet Seat				Simple
		SPECIFICATIONS		
		Raised toilet seat 207x266mm inside aperture		
SUPPLIER/BRAND		MAX USER WEIGHT		
AT Therapy/Savanah		190kg		
SUPPLIER PRODUCT ID	ENZ LIST CODE	HEIGHT	ACC SIC CODE	
PAT-AA2112	ENZA32	50mm	ET045	
PAT-AA2114Y	ENZA33	100mm	ET044	

Toilet Seat				Simple
		SPECIFICATIONS		
		Raised toilet seat 215x260mm inside aperture		
SUPPLIER/BRAND		MAX USER WEIGHT		
Etac/Cubro		150kg		
SUPPLIER PRODUCT ID	ENZ LIST CODE	HEIGHT	ACC SIC CODE	
5450	ENZA3453	60mm	ET043	
5451	ENZA3454	100mm	ET042	

Bottom Wiper			Simple
		SPECIFICATIONS	
		Toileting bottom wiper 265mm length.	
SUPPLIER/BRAND		MAX USER WEIGHT	
AT Therapy/Homecare		N/A	
SUPPLIER PRODUCT ID	ENZ LIST CODE	ACC SIC CODE	
PAT-AA2650	ENZA285	ET021	

# ACC Simple List Equipment

## Wheelchairs & Seating

Cushion				Simple
		<b>SPECIFICATIONS</b>		
		Komfit Cushion		
<b>SUPPLIER/BRAND</b>		<b>MAX USER WEIGHT</b>		
Permobil/Komfit		95kg		
SUPPLIER PRODUCT ID	ENZ LIST CODE	SIZE	ACC SIC CODE	
CU502	ENZA74	16x16	EK109	
CU505	ENZA75	18x18	EK111	

Wheelchair - Transit				Simple
		<b>SPECIFICATIONS</b>		
		Action 1R Folding Frame Transit wheelchair  12" Transit Wheels 80 degree removeable swing away Flip up footplate Push brakes		
<b>SUPPLIER/BRAND</b>		<b>MAX USER WEIGHT</b>		
Invacare/Action 1R		125kg		
SUPPLIER PRODUCT ID	ENZ LIST CODE	SIZE	ACC SIC CODE	
PKG-DK1640990	ENZA133	16x16.75	EM073	
PKG-DK1640992	ENZA134	18x16.75	EM073	
ACCESSORIES - Elevating legrests				
DESCRIPTION	ENZ LIST CODE	SUPPLIER PRODUCT ID	ACC SIC CODE	
Right hand side 16"	ENZA68	1562037	EM086	
Left hand side 16"	ENZA69	1562008	EM087	
Right hand side 18"	ENZA70	1562039	EM088	
Left hand side 18"	ENZA71	1562038	EM089	

# ACC Simple List Equipment

## Wheelchairs & Seating

Wheelchair - Self Propelling				Simple
		<b>SPECIFICATIONS</b>		
		Action 1R Folding Frame Self propelling wheelchair  24" Rear wheels 80 degree removeable swing away Flip up footplate Push brakes		
<b>SUPPLIER/BRAND</b>		<b>MAX USER WEIGHT</b>		
Invacare/Action 1R		125kg		
SUPPLIER PRODUCT ID	ENZ LIST CODE	SIZE	ACC SIC CODE	
PKG-DK1640966	ENZA131	16x16.75	EM072	
PKG-DK1640968	ENZA132	18x16.75	EM072	
ACCESSORIES - Elevating legrests				
DESCRIPTION	ENZ LIST CODE	SUPPLIER PRODUCT ID	ACC SIC CODE	
Right hand side 16"	ENZA68	1562037	EM086	
Left hand side 16"	ENZA69	1562008	EM087	
Right hand side 18"	ENZA70	1562039	EM088	
Left hand side 18"	ENZA71	1562038	EM089	

Ramps				Simple
		<b>SPECIFICATIONS</b>		
		Aluminium ramp with non-skid surface		
<b>SUPPLIER/BRAND</b>		<b>MAX USER WEIGHT</b>		
Cubro/EuroRamps		287kg		
SUPPLIER PRODUCT ID	ENZ LIST CODE	SIZE	ACC SIC CODE	
547	ENZA91	25mm H x 125mm L x 850mm W	EM109	
548	ENZA98	50mm H x 250mm L x 850mm	EM110	
549	ENZA111	75mm H x 375mm L x 850mm W	EM111	

# ACC Simple List Equipment

## Daily Living Aids

Dressing & Grooming			Simple
		<b>SPECIFICATIONS</b>	
		Sock aid Standard	
<b>SUPPLIER/BRAND</b>		<b>MAX USER WEIGHT</b>	
Allied Medical/Parsons		N/A	
<b>SUPPLIER PRODUCT ID</b>	<b>ENZ LIST CODE</b>	<b>ACC SIC CODE</b>	
PA16D005	ENZA18	EC070	

Dressing & Grooming			Simple
		<b>SPECIFICATIONS</b>	
		Shoe horn - Metal 24"	
<b>SUPPLIER/BRAND</b>		<b>MAX USER WEIGHT</b>	
Mobility Supplies NZ		N/A	
<b>SUPPLIER PRODUCT ID</b>	<b>ENZ LIST CODE</b>	<b>ACC SIC CODE</b>	
1028S	ENZA279	EO002	

Reacher				Simple
		<b>SPECIFICATIONS</b>		
		Reacher Magnetic tip		
<b>SUPPLIER/BRAND</b>		<b>MAX USER WEIGHT</b>		
Cubro/Hull		N/A		
<b>SUPPLIER PRODUCT ID</b>	<b>ENZ LIST CODE</b>	<b>SIZE</b>	<b>ACC SIC CODE</b>	
144	ENZA281	25.6" (600mm)	EK050	
146	ENZA282	32.5" (700mm)	EK051	

# ACC Simple List Equipment

## Daily Living Aids

Seat & Back Cushion			Simple
		<b>SPECIFICATIONS</b>	
		Obusforme contoured seat cushion 40x45cm	
<b>SUPPLIER/BRAND</b>		<b>MAX USER WEIGHT</b>	
Amtech Medical Aid		N/A	
<b>SUPPLIER PRODUCT ID</b>	<b>ENZ LIST CODE</b>	<b>ACC SIC CODE</b>	
SU442	ENZA55	EK104	

Seat & Back Cushion			Simple
		<b>SPECIFICATIONS</b>	
		BackFriend back & seat cushion	
<b>SUPPLIER/BRAND</b>		<b>MAX USER WEIGHT</b>	
Ergogo		N/A	
<b>SUPPLIER PRODUCT ID</b>	<b>ENZ LIST CODE</b>	<b>SIZE</b>	<b>ACC SIC CODE</b>
BF1/1	ENZA104	Standard	EK105

Seat & Back Cushion			Simple
		<b>SPECIFICATIONS</b>	
		BackFriend back only	
<b>SUPPLIER/BRAND</b>		<b>MAX USER WEIGHT</b>	
Ergogo		N/A	
<b>SUPPLIER PRODUCT ID</b>	<b>ENZ LIST CODE</b>	<b>SIZE</b>	<b>ACC SIC CODE</b>
BF3	ENZA64	Standard	EK107



# ACC Simple List Equipment

## Daily Living Aids

Seat & Back Cushions			Simple
		<b>SPECIFICATIONS</b>	
		Obusforme low back rest  53x45cm	
<b>SUPPLIER/BRAND</b>		<b>MAX USER WEIGHT</b>	
Amtech Medical Aid		N/A	
<b>SUPPLIER PRODUCT ID</b>	<b>ENZ LIST CODE</b>	<b>ACC SIC CODE</b>	
SU434	ENZA62	EK106	

Seat & Back Cushion			Simple
		<b>SPECIFICATIONS</b>	
		Obusforme high back rest  78cmx43cm	
<b>SUPPLIER/BRAND</b>		<b>MAX USER WEIGHT</b>	
Amtech Medical Aid		N/A	
<b>SUPPLIER PRODUCT ID</b>	<b>ENZ LIST CODE</b>	<b>ACC SIC CODE</b>	
SU435	ENZA73	EK108	

# ACC Simple List Equipment

## Daily Living Aids

Exercise & Therapy			Simple
		<b>SPECIFICATIONS</b>	
		Xterra U15 Exercise bike  Battery operated Console Height adjustable seat range (660-1000mm) Height adjustable seat (560-900 seat to pedal)  Note: Fuel 3.0 will be issued if reissue stock is available	
<b>SUPPLIER/BRAND</b>		<b>MAX USER WEIGHT</b>	
Bernsport		120kg	
<b>SUPPLIER PRODUCT ID</b>	<b>ENZ LIST CODE</b>	<b>ACC SIC CODE</b>	
DYXT000	ENZA172	EO003	

Exercise & Therapy			Simple
		<b>SPECIFICATIONS</b>	
		Fortress Tens physical therapy with standard accessories (Electrodes)  1000x610x1420mm	
<b>SUPPLIER/BRAND</b>		<b>MAX USER WEIGHT</b>	
Amtech Medical Aid		N/A	
<b>SUPPLIER PRODUCT ID</b>	<b>ENZ LIST CODE</b>	<b>ACC SIC CODE</b>	
PD100	ENZA39	EO101	

# ACC

# Standard List Equipment

## Table of Contents

Bedroom	46
Kitchen & Living	47
Office	48
Patient Lifters	49
Shower & Bath	53
Wheelchair & Seating	54

# ACC Standard List Equipment

## Bedroom

Bed & Accessories			Standard
		<b>SPECIFICATIONS</b> Bed Etude Plus 4 section Hi-Lo Includes bed ends Accessories below  2190x1020mm overall size 330-730 or 400-800mm adjustable height	
<b>SUPPLIER/BRAND</b>		<b>MAX USER WEIGHT</b>	
Invacare/Etude		165kg	
<b>SUPPLIER PRODUCT ID</b>	<b>ENZ LIST CODE</b>	<b>ACC SIC CODE</b>	
PKG-ETUDE PLUS STD	ENZA204	EC102	
ACCESSORIES			
DESCRIPTION	ENZ LIST CODE	SUPPLIER PRODUCT ID	ACC SIC CODE
Bed Extn 15cm incl mattress	ENZA115	BEDEXTKITP10	EC101
Cotside 3/4 Foldable Right	ENZA95	1528931-7035	EC111
Cotside 3/4 foldable Left	ENZA94	1529272-7035	EC111
Overbed pole	ENZA89	154093-0152	EC130

Mattress			Standard
		<b>SPECIFICATIONS</b> Softform premier  1970x800x152mm	
<b>SUPPLIER/BRAND</b>		<b>MAX USER WEIGHT</b>	
Invacare/Softform		247.6kg	
<b>SUPPLIER PRODUCT ID</b>	<b>ENZ LIST CODE</b>	<b>ACC SIC CODE</b>	
1486720	ENZA176	EC123	

# ACC Standard List Equipment

## Kitchen & Living

Lift Out Chair		Standard
		SPECIFICATIONS
		Dual motor Rechargeable battery backup Removable back  900mm overall width 440mm width between arms 530mm seat depth
SUPPLIER/BRAND		MAX USER WEIGHT
Goldfern Mobility		150kg
SUPPLIER PRODUCT ID	ENZ LIST CODE	ACC SIC CODE
GM-HYE-8063	ENZA67	EK120

# ACC Standard List Equipment

## Office

Office Chair		Standard
	<b>SPECIFICATIONS</b>	
	Chorus 3.5 high back chair 3 Lever Black  Back 470mm 420-550mm adjustable height 480mmx490mm seat size	
<b>SUPPLIER/BRAND</b>		<b>MAX USER WEIGHT</b>
Bytes & Pieces		140kg
<b>SUPPLIER PRODUCT ID</b>	<b>ENZ LIST CODE</b>	<b>ACC SIC CODE</b>
E-Chorus3.50	ENZA146	EF115

Hi Lo Desk		Standard
	<b>SPECIFICATIONS</b>	
	Hi Lo electric desk  1200mmx800mm 620-1275mm adjustable height	
<b>SUPPLIER/BRAND</b>		<b>MAX USER WEIGHT</b>
Bytes & Pieces		N/A
<b>SUPPLIER PRODUCT ID</b>	<b>ENZ LIST CODE</b>	<b>ACC SIC CODE</b>
OI-01	ENZA193	EF120

# ACC Standard List Equipment

## Patient Lifters

Hoist		Standard	
		<b>SPECIFICATIONS</b>	
		Birdie Evo Compact Manual Legs Hoist frame with Pivot or Spreader bar  520mm overall width closed (external) 815mm Internal width legs open 1070mm turning radius Lifting range 530mm -1590mm	
<b>SUPPLIER/BRAND</b>		<b>MAX USER WEIGHT</b>	
Invacare/Birdie		150kg	
SUPPLIER PRODUCT ID	ENZ LIST CODE	DESCRIPTION	ACC SIC CODE
PKG-EVOCOMPACTPIVOT	ENZA11472	Birdie Evo Compact with Pivot	EH110
PKG-EVOCOMPACTSTD	ENZA11473	Birdie Evo Compact with Spreader	EH110

Hoist		Standard	
		<b>SPECIFICATIONS</b>	
		Birdie Evo Electric Legs Hoist with Pivot or Spreader Bar  640mm overall width closed (external) 1020mm Internal width legs open 1400mm turning radius Lifting range 415mm -1660mm	
<b>SUPPLIER/BRAND</b>		<b>MAX USER WEIGHT</b>	
Invacare/Birdie		180kg	
SUPPLIER PRODUCT ID	ENZ LIST CODE	DESCRIPTION	ACC SIC CODE
PKG-EVO180PIVOT	ENZA11470	Birdie Evo with Pivot	EH111
PKG-EVO180STD	ENZA11471	Birdie Evo with Spreader	EH111

# ACC Standard List Equipment

## Patient Lifters

Yoke Sling				Standard
		<b>SPECIFICATIONS</b>		
		Universal High sling Fabric For use with Birdie Evo and Birdie Evo Compact hoists		
<b>SUPPLIER/BRAND</b>		<b>MAX USER WEIGHT</b>		
Invacare/Optisling		N/A		
SUPPLIER PRODUCT ID	ENZ LIST CODE	SIZE	ACC SIC CODE	
60124058	ENZA148	X-Small	EH117	
60124059	ENZA149	Small	EH117	
60124060	ENZA150	Medium	EH117	
60124061	ENZA151	Large	EH117	
60124062	ENZA152	X-Large	EH117	

Yoke Sling				Standard
		<b>SPECIFICATIONS</b>		
		Universal High sling Mesh For use with Birdie Evo and Birdie Evo Compact hoists		
<b>SUPPLIER/BRAND</b>		<b>MAX USER WEIGHT</b>		
Invacare/Optisling		N/A		
SUPPLIER PRODUCT ID	ENZ LIST CODE	SIZE	ACC SIC CODE	
60124064	ENZA153	Small	EH117	
60124065	ENZA154	Medium	EH117	
60124066	ENZA155	Large	EH117	
60124067	ENZA156	XLarge	EH117	



# ACC Standard List Equipment

## Patient Lifters

Yoke Sling				Standard
		<b>SPECIFICATIONS</b>		
		Hygiene High sling Fabric For use with Birdie Evo and Birdie Evo Compact hoists		
<b>SUPPLIER/BRAND</b>		<b>MAX USER WEIGHT</b>		
Invacare/Optisling		N/A		
SUPPLIER PRODUCT ID	ENZ LIST CODE	SIZE	ACC SIC CODE	
60123894	ENZA157	X-Small	EH117	
60123895	ENZA158	Small	EH117	
60123896	ENZA159	Medium	EH117	
60123897	ENZA160	Large	EH117	
60123898	ENZA161	X-Large	EH117	

Pivot Sling				Standard
		<b>SPECIFICATIONS</b>		
		Pivot sling General Purpose with Head Support Mesh For use with the Birdie Compact with pivot attachment		
<b>SUPPLIER/BRAND</b>		<b>MAX USER WEIGHT</b>		
Invacare/Novis		N/A		
SUPPLIER PRODUCT ID	ENZ LIST CODE	SIZE	ACC SIC CODE	
SL146191	ENZA162	Small	EH117	
SL146291	ENZA163	Medium	EH117	
SL146391	ENZA164	Large	EH117	

# ACC Standard List Equipment

## Patient Lifters

Pivot Sling			Standard
		<b>SPECIFICATIONS</b>	
		Pivot sling Hygiene Mesh For use with the Birdie Compact with pivot attachment	
<b>SUPPLIER/BRAND</b>		<b>MAX USER WEIGHT</b>	
Invacare/Novis		N/A	
SUPPLIER PRODUCT ID	ENZ LIST CODE	SIZE	ACC SIC CODE
SL247191	ENZA165	Small	EH117
SL247291	ENZA166	Medium	EH117
SL247391	ENZA167	Large	EH117

# ACC Standard List Equipment

## Shower & Bath

Bath Lifter		Standard	
		<b>SPECIFICATIONS</b>	
		Bath lift Orca XL 375mm seat width without side flaps 715mm seat width with side flaps 580x285mm base area	
<b>SUPPLIER/BRAND</b>		<b>MAX USER WEIGHT</b>	
Invacare/Aquatech		170kg	
<b>SUPPLIER PRODUCT ID</b>	<b>ENZ LIST CODE</b>	<b>ACC SIC CODE</b>	
1573744	ENZA179	EH102	

# ACC Standard List Equipment

## Wheelchair & Seating

Wheelchair - Transit Peadiatric				Standard
		<b>SPECIFICATIONS</b>		
		Manual Action 3 Transit Junior  <b>Base unit includes:</b>  <b>Action 3 Junior</b> <ul style="list-style-type: none"> <li>• Wheelchair sizes: 8-11x10-12, 8-11x12-14, 12-15x11-13, 12-15x13-15</li> <li>• Available in two colours – Matte Red and Polar Blue</li> <li>• Front castor Wheels 5"</li> <li>• Transit wheels 12"</li> <li>• Leg rest hangers available in 80 degree swing away or 90 degree</li> <li>• Footrests Flip Up Angle and Depth adjustable</li> <li>• Seat Upholstery Nylon adjustable</li> <li>• Back Upholstery Nylon adjustable</li> <li>• Back Canes fixed height 0 degree</li> <li>• Armrests removable height adjustable with skirt guard</li> <li>• Push to Lock Brakes</li> <li>• Seat Belt</li> <li>• Anti-Tippers</li> </ul>		
<b>SUPPLIER/BRAND</b>		<b>MAX USER WEIGHT</b>		
Invacare/Action 3		80kg		
SUPPLIER PRODUCT ID	ENZ LIST CODE	COLOUR	SIZE	ACC SIC CODE
EF1672195-TR	ENZA216	BLUE	8-11x10-12	EM071
EF1672197-TR	ENZA217	BLUE	8-11x12-14	EM071
EF1672199-TR	ENZA218	BLUE	12-15x11-13	EM071
EF1672201-TR	ENZA219	BLUE	12-15x13-15	EM071
EF1672194-TR	ENZA12113	RED	8-11x10-12	EM071
EF1672196-TR	ENZA12112	RED	8-11x12-14	EM071
EF1672198-TR	ENZA12111	RED	12-15x11-13	EM071
EF1672200-TR	ENZA12110	RED	12-15x13-15	EM071

# ACC Standard List Equipment

## Wheelchair & Seating

Wheelchair - Self Propelling Peadiatric				Standard
		<b>SPECIFICATIONS</b>  Action 3 Junior Folding Frame  <b>Base unit includes:</b>  <b>Action 3 Junior</b> <ul style="list-style-type: none"> <li>• Wheelchair sizes: 8-11x10-12, 8-11x12-14,</li> <li>• 12-15x11-13, 12-15x13-15</li> <li>• Available in two colours – Matte Red and Polar Blue</li> <li>• Self Propelling (22" rear wheel)</li> <li>• Front castor Wheels 5"</li> <li>• Leg rest hangers available in 80 degree swing away or 90 degree</li> <li>• Footrests Flip Up Angle and Depth adjustable</li> <li>• Seat Upholstery Nylon adjustable</li> <li>• Back Upholstery Nylon adjustable</li> <li>• Back Canes fixed height 0 degree</li> <li>• Armrests removable height adjustable with skirt guard</li> <li>• Push to Lock Brakes</li> <li>• Seat Belt</li> <li>• Anti-Tippers</li> </ul>		
		<b>SUPPLIER/BRAND</b> Invacare/Action 3		<b>MAX USER WEIGHT</b> 80kg
SUPPLIER PRODUCT ID	ENZ LIST CODE	COLOUR	SIZE	ACC SIC CODE
EF1672195	ENZA212	BLUE	8-11x10-12	EM070
EF1672197	ENZA213	BLUE	8-11x12-14	EM070
EF1672199	ENZA214	BLUE	12-15x11-13	EM070
EF1672201	ENZA215	BLUE	12-15x13-15	EM070
EF1672194	ENZA12117	RED	8-11x10-12	EM070
EF1672196	ENZA12116	RED	8-11x12-14	EM070
EF1672198	ENZA12115	RED	12-15x11-13	EM070
EF1672200	ENZA12114	RED	12-15x13-15	EM070

# ACC Standard List Equipment

## Wheelchair & Seating

Wheelchair - Self Propelling Paediatric		Standard	
		<b>SPECIFICATIONS</b>	
		Manual self propelling Karma Flexx Junior Folding Frame <ul style="list-style-type: none"> <li>• Quick release 20" rear wheels</li> <li>• 5" front castor</li> <li>• Standard 2 point hip belt</li> <li>• Height adjustable, flip back armrests</li> <li>• Heel loops</li> <li>• 90 degree legrests with fixed angle foot rest</li> <li>• Back angle adjustment (-4° to 16°)</li> <li>• Removable anti-tippers</li> <li>• Push to lock brakes</li> </ul>	
<b>SUPPLIER/BRAND</b>		<b>MAX USER WEIGHT</b>	
Allied Medical/Karma Flexx		75kg	
<b>SUPPLIER PRODUCT ID</b>	<b>ENZ LIST CODE</b>	<b>SIZE</b>	<b>ACC SIC CODE</b>
KMFLEXXSPJR1011	ENZA207	10x11	<b>EM064</b>
KMFLEXXSPJR1212	ENZA208	12x12	<b>EM064</b>
KMFLEXXSPJR1414	ENZA209	14x14	<b>EM064</b>

# ACC Standard List Equipment

## Wheelchair & Seating

Wheelchair Standard Minimal-Adjustable		Standard		
		<b>SPECIFICATIONS</b>		
		<p><b>Karma Flexx</b> Folding <b>Base unit includes:</b> Karma Flexx Wheelchair sizes: 14x16, 16x16, 16x18, 16x20, 18x16, 18x18, 18x20</p> <ul style="list-style-type: none"> <li>• Standard seat and back upholstery</li> <li>• 7" castor</li> <li>• 24" pneumatic rear wheel with quick release axle (Self Propelled) or 14" rear wheel (Transit)</li> <li>• Height adjustable, flip back desk armrest</li> <li>• Calf strap</li> <li>• 80 deg legrests with fixed angle foot rest</li> <li>• 2point hip belt</li> <li>• Back angle adjustment (-4° to +16°)</li> <li>• Removable antitipper</li> <li>• Push to lock brakes</li> <li>• Fixed back canes Flexx height 17"</li> <li>• Fixed back canes Flexx Tall height 20"</li> </ul> <p><b>Option extra adjustable Back Canes</b></p> <ul style="list-style-type: none"> <li>• Adjustable back canes 15-20"</li> </ul>		
<b>SUPPLIER/BRAND</b>		<b>MAX USER WEIGHT</b>		
Allied Medical/Karma		130kg		
DESCRIPTION	ENZ LIST CODE	SUPPLIER PRODUCT ID	SIZE	ACC SIC CODE
Karma Flexx Transit base unit	ENZA7965	KMFLEXXSTR1416	14X16	<b>EM160</b>
	ENZA5239	KMFLEXXSTR1616	16X16	<b>EM161</b>
	ENZA6434	KMFLEXXSTR1618	16X18	<b>EM162</b>
	ENZA6727	KMFLEXXSTR1816	18X16	<b>EM163</b>
	ENZA6683	KMFLEXXSTR1818	18X18	<b>EM164</b>
Karma Flexx Tall Transit base unit	ENZA7966	KMFLEXXTLTR1620	16X20	<b>EM165</b>
	ENZA7967	KMFLEXXTLTR1820	18X20	<b>EM166</b>
Karma Flexx Self Propelled base unit	ENZA847	KMFLEXXSP1416	14X16	<b>EM167</b>
	ENZA844	KMFLEXXSP1616	16X16	<b>EM168</b>
	ENZA845	KMFLEXXSP1618	16X18	<b>EM169</b>
	ENZA7968	KMFLEXXSP1816	18X16	<b>EM170</b>
	ENZA1518	KMFLEXXSP1818	18X18	<b>EM171</b>
Karma Flexx Tall Self Propelled base unit	ENZA7406	KMFLEXXTLSP1620	16X20	<b>EM172</b>
	ENZA841	KMFLEXXTLSP1820	18X20	<b>EM173</b>

# ACC Standard List Equipment

## Wheelchair & Seating

Wheelchair Standard Minimal-Adjustable		Standard		
		<b>SPECIFICATIONS</b>  <b>Karma Flexx HD</b> Folding <b>Base unit includes:</b> Karma Flexx HD Wheelchair sizes: 20x18, 20x20, 22x18, 22x20, 24x18 <ul style="list-style-type: none"> <li>• Standard seat and back upholstery</li> <li>• 7" castor</li> <li>• 24" pneumatic rear wheel with quick release axle</li> <li>• (Self Propelled) or 14" rear wheel (Transit)</li> <li>• Height adjustable, flip back desk armrest</li> <li>• Heel loops</li> <li>• 80 deg legrests with fixed angle foot rest</li> <li>• 2point hip belt</li> <li>• Back angle adjustment (-4° to +16°)</li> <li>• Removable antitipper</li> <li>• Push to lock brakes</li> <li>• Rigidising Bar (which doubles as a push handle)</li> <li>• Fixed back canes Flexx HD height 17"</li> </ul> <b>Option extra adjustable Back Canes</b> <ul style="list-style-type: none"> <li>• Adjustable back canes 15-20"</li> </ul>		
		<b>SUPPLIER/BRAND</b> Allied Medical/Karma		<b>MAX USER WEIGHT</b> 170kg
DESCRIPTION	ENZ LIST CODE	SUPPLIER PRODUCT ID	SIZE	ACC SIC CODE
Karma Flexx HD Transit base unit	ENZA3525	KMFLEXXHDTR2018	20x18	<b>EM174</b>
	ENZA7969	KMFLEXXHDTR2020	20x20	<b>EM175</b>
	ENZA7970	KMFLEXXHDTR2218	22x18	<b>EM176</b>
	ENZA7972	KMFLEXXHDTR2220	22x20	<b>EM177</b>
	ENZA7973	KMFLEXXHDTR2418	24x18	<b>EM178</b>
	ENZA7974	KMFLEXXHDTR2420	24x20	<b>EM179</b>
Karma Flexx HD Self Propelled base unit	ENZA843	KMFLEXXHDSP2018	20x18	<b>EM180</b>
	ENZA842	KMFLEXXHDSP2020	20x20	<b>EM181</b>
	ENZA7975	KMFLEXXHDSP2218	22x18	<b>EM182</b>
	ENZA2194	KMFLEXXHDSP2220	22x20	<b>EM183</b>
	ENZA4997	KMFLEXXHDSP2418	24x18	<b>EM184</b>
	ENZA7976	KMFLEXXHDSP2420	24x20	<b>EM185</b>



# ACC Standard List Equipment

## Wheelchair & Seating

Wheelchair - Transit				Standard
		<b>SPECIFICATIONS</b>		
		Manual Action 3 Transit  12" Wheels 8" Castors		
<b>SUPPLIER/BRAND</b>		<b>MAX USER WEIGHT</b>		
Invacare/Action 3		125kg		
SUPPLIER PRODUCT ID	ENZ LIST CODE	SIZE	ACC SIC CODE	
CS1567978	ENZA182	16x16	EM055	
CS1552784	ENZA183	18x18	EM055	
CS1567979	ENZA184	18x16	EM055	
CS1552843	ENZA185	18x18	EM055	
CS1552844	ENZA186	20x18	EM055	

Wheelchair - Transit				Standard
		<b>SPECIFICATIONS</b>		
		Manual Action 3 self propelling  24" Wheels 8" Castors		
<b>SUPPLIER/BRAND</b>		<b>MAX USER WEIGHT</b>		
Invacare/Action 3		125kg		
SUPPLIER PRODUCT ID	ENZ LIST CODE	SIZE	ACC SIC CODE	
CS1567975	ENZA187	16x16	EM056	
CS1552711	ENZA188	18x18	EM056	
CS1567976	ENZA189	18x16	EM056	
CS1552769	ENZA190	18x18	EM056	
CS1552770	ENZA191	20x18	EM056	

# ACC

# Complex List Equipment

## Table of Contents

Bedroom	60
Shower & Bath	61
Wheelchair & Seating	63

# ACC Complex List Equipment

## Bedroom

Bed		Complex	
		<b>SPECIFICATIONS</b>	
		Bock Belluno 4 section bed 1030x2160mm size 70 degrees angle adjustment 150mm clearance height	
<b>SUPPLIER/BRAND</b>		<b>MIN/MAX USER WEIGHT</b>	
Cubro/Bock		MIN 40kg MAX 165kg	
SUPPLIER PRODUCT ID	ENZ LIST CODE	SIZE	ACC SIC CODE
921/WA	ENZA237	110cm Super single	EC103
922/WA	ENZA239	140cm Double	EC104

Mattress		Complex	
		<b>SPECIFICATIONS</b>	
		Posture Temp pressure relieving mattress 150mm height Sizes below	
<b>SUPPLIER/BRAND</b>		<b>USER WEIGHT RANGE</b>	
Cubro/Posture Temp		20-120kg	
SUPPLIER PRODUCT ID	ENZ LIST CODE	SIZE	ACC SIC CODE
994	ENZA210	Super Single 1100x2000mm	EC124
992	ENZA221	Double 1400x2000mm	EC125

# ACC Complex List Equipment

## Shower & Bath

Shower Cubicle			Complex
		<b>SPECIFICATIONS</b>	
		Careport extra freestanding shower system incl doors,ramp Pump Control Unit Shower slide & mixer Handrails (excl installation)  1200x1400x2100mm  <b>PLEASE NOTE: QUOTE IS REQUIRED WITH REQUEST &amp; MUST BE PART OF AN APPROVED HOUSING MODIFICATION SERVICE</b>	
<b>SUPPLIER/BRAND</b>		<b>MAX USER WEIGHT</b>	
Active Healthcare/Careport		N/A	
<b>SUPPLIER PRODUCT ID</b>	<b>ENZ LIST CODE</b>	<b>ACC SIC CODE</b>	
0151-0801	ENZA223	EB110	

Shower Commode			Complex
		<b>SPECIFICATIONS</b>	
		Shower commode self propelled Frame only  460mm width between arms <b>Seat not included please select accessories below</b>	
<b>SUPPLIER/BRAND</b>		<b>MAX USER WEIGHT</b>	
Cubro/Viking		200kg	
<b>SUPPLIER PRODUCT ID</b>	<b>ENZ LIST CODE</b>	<b>ACC SIC CODE</b>	
966	ENZA223	EB121	
ACCESSORIES			
DESCRIPTION	ENZ LIST CODE	SUPPLIER PRODUCT ID	ACC SIC CODE
Closed Seat	ENZA3456	75PC/75PR	EB108
Open Seat	ENZA3455	75PO/75PR	EB108

# ACC Complex List Equipment

## Shower & Bath

Shower Commode			Complex
		<b>SPECIFICATIONS</b>	
		Shower commode Attendant propelled Frame only  460mm width between arms <b>Seat not included please select accessories below</b>	
<b>SUPPLIER/BRAND</b>		<b>MAX USER WEIGHT</b>	
Cubro/Viking		200kg	
<b>SUPPLIER PRODUCT ID</b>	<b>ENZ LIST CODE</b>	<b>ACC SIC CODE</b>	
960	ENZA222	EB122	
ACCESSORIES			
DESCRIPTION	ENZ LIST CODE	SUPPLIER PRODUCT ID	ACC SIC CODE
Closed Seat	ENZA3456	75PC/75PR	EB108
Open Seat	ENZA3455	75PO/75PR	EB108

Shower Commode			Complex
		<b>SPECIFICATIONS</b>	
		Viking RAZ TNS  <b>Base unit includes:</b> <ul style="list-style-type: none"> <li>Viking RAZ TNS 16,18 and 20</li> <li>Adjusta-Back - 430mm (20") H</li> <li>Fabric back, 20" high</li> <li>Molded Headrest - incl. stainless steel fixing</li> <li>RAZ Molded Seat 450mmW x 400mmD -</li> <li>Set of clips etc to fit seats on RAZ commodes</li> <li>H-Strap (attached to footrests for calf support)</li> <li>Adjustable Footrest 410-520mm</li> </ul> <b>PLEASE NOTE: QUOTE IS REQUIRED WITH REQUEST.</b>	
<b>SUPPLIER/BRAND</b>		<b>MAX USER WEIGHT</b>	
Cubro/Raz		185kg	
<b>SUPPLIER PRODUCT ID</b>	<b>ENZ LIST CODE</b>	<b>SIZE</b>	<b>ACC SIC CODE</b>
9902	ENZA260	16" Open Seat Base Unit	EB125
9904	ENZA261	18" Open Seat Base Unit	EB125
9906	ENZA262	20" Open Seat Base Unit	EB125
9903	ENZA263	16" Closed Seat Base Unit	EB125
9905	ENZA264	18" Closed Seat Base Unit	EB125
9907	ENZA265	20" Closed Seat Base Unit	EB125

# ACC Complex List Equipment

## Wheelchair & Seating

Wheelchair - Tilt n Space				Complex
		<b>SPECIFICATIONS</b> Solara 3G Rigid  <b>Base unit includes:</b>  <b>Solara 3G</b> <ul style="list-style-type: none"> <li>• Frame sizes: 12-24x12-22</li> <li>• Width and Depth Adjustable Frame</li> <li>• Tilt in Space Frame</li> <li>• Stroller Handles</li> <li>• Foot operated brake</li> <li>• Foot operated tilt</li> <li>• 12" or 24" Rear Wheels</li> <li>• 70 Degree Swingaway Legrests with angle adjustable footplates</li> <li>• Dual post flip back, height adjustable armrest with full-length armpad</li> <li>• 2 Point Freedom belt</li> <li>• Tie Downs</li> <li>• Colour Black</li> </ul>		
		<b>PLEASE NOTE: QUOTE IS REQUIRED WITH REQUEST.</b>		
<b>SUPPLIER/BRAND</b>		<b>MAX USER WEIGHT</b>		
Invacare/Solara		136kg		
SUPPLIER PRODUCT ID	ENZ LIST CODE	SIZE	ACC SIC CODE	
SOLARA3G-C	ENZA251	14-18x15-19	EM105	
SOLARA3G-B	ENZA252	14-18x12-16	EM105	
SOLARA3G-D	ENZA253	16-20x15-19	EM105	
SOLARA3G-E	ENZA254	16-20x18-22	EM105	

Wheelchair - Tilt n Space				Complex
		<b>SPECIFICATIONS</b> Pro CG tilt n space wheelchair  15"-19" (-1.5" with drop base) 0 - 50 degree Tilt n Space range 12 1/2" Transit wheels  <b>PLEASE NOTE: QUOTE IS REQUIRED WITH REQUEST.</b>		
		<b>PLEASE NOTE: QUOTE IS REQUIRED WITH REQUEST.</b>		
<b>SUPPLIER/BRAND</b>		<b>MAX USER WEIGHT</b>		
Invacare/Pro CG		113kg		
SUPPLIER PRODUCT ID	ENZ LIST CODE	SIZE	ACC SIC CODE	
	ENZA255	12-14x12-16	EM126	
	ENZA256	14-16x14-18	EM126	
	ENZA257	16-18x16-20	EM126	
	ENZA258	18-20x18-22	EM126	

# ACC Complex List Equipment

## Wheelchair & Seating

Wheelchair - Tilt n Space		Complex	
		<b>SPECIFICATIONS</b>  Zippie Iris Rigid  <b>Base unit includes:</b>  <b>Zippie Iris</b> Frame sizes: 10-14x10-18 <ul style="list-style-type: none"> <li>• True-ft growth system</li> <li>• Tie downs</li> <li>• Width adjusting system</li> <li>• Short, medium and long seat frame</li> <li>• 5" x 1.5" semi pneumatic front castors</li> <li>• 16" Rear mag wheels; pneumatic</li> <li>• 90° legrest hangers with angle adjustable footplates</li> <li>• Offset hanger mounts</li> <li>• Single post height adjustable arm supports with full-length pads</li> <li>• Height adjustable push handle</li> <li>• Growable seat pan</li> <li>• Anti-tips</li> <li>• Black Opal frame colour</li> <li>• Foot operated tilt</li> <li>• Foot operated brakes</li> </ul>	
		<b>Accessories:</b> <b>ENZ LIST CODE:</b> ENZA14 <b>ACC SIC CODE:</b> EM151A  <a href="#">Click here for script form</a>  <b>PLEASE NOTE: QUOTE &amp; ACCESSORY CODE IS REQUIRED WITH REQUEST.</b>	
<b>SUPPLIER/BRAND</b>		<b>MAX USER WEIGHT</b>	
Medifab/Zippie		135kg	
<b>SUPPLIER PRODUCT ID</b>	<b>ENZ LIST CODE</b>	<b>SIZE (width x depth)</b>	<b>ACC SIC CODE</b>
1562	ENZA241	12-19x12-19	<b>EM151</b>
1562	ENZA5763	12-19x20 & 20x12-19	<b>EM151</b>
1562	ENZA5764	20x20	<b>EM151</b>
1562	ENZA5765	10-14x10-18	<b>EM151</b>

# ACC Complex List Equipment

## Wheelchair & Seating

Wheelchair - Tilt n Space		Complex	
		<b>SPECIFICATIONS</b> Quickie Iris Rigid  <b>Base unit includes:</b>  <b>Quickie Iris Medium</b> Frame sizes: 14-20x16-20 <ul style="list-style-type: none"> <li>• True-ft growth system</li> <li>• Tie downs</li> <li>• Width adjusting system</li> <li>• Medium seat frame</li> <li>• 6" x 1.5" semi pneumatic front castors</li> <li>• 16" Rear mag wheels; pneumatic</li> <li>• 80° legrest hangers with angle adjustable footplates</li> <li>• Single post height adjustable arm supports with full-length pads</li> <li>• Height adjustable push handle</li> <li>• Growable seat pan</li> <li>• Anti-tips</li> <li>• Black Opal frame colour</li> <li>• Foot operated tilt and brakes</li> </ul> <b>Quickie Iris Long</b> Frame sizes: 14-20x18-22 <ul style="list-style-type: none"> <li>• True-ft growth system</li> <li>• Tie downs</li> <li>• Width adjusting system</li> <li>• Long seat frame</li> <li>• 6" x 1.5" semi pneumatic front castors</li> <li>• 16" Rear mag wheels; pneumatic</li> <li>• 80° legrest hangers with angle adjustable footplates</li> <li>• Single post height adjustable arm supports with full-length pads</li> <li>• Height adjustable push handle</li> <li>• Growable seat pan</li> <li>• Anti-tips</li> <li>• Black Opal frame colour</li> <li>• Foot operated tilt and brakes</li> </ul> <b>Accessories:</b> <b>ENZ LIST CODE:</b> ENZA15 <b>ACC SIC CODE:</b> EM152A  <a href="#">Click here for script form</a>  <b>PLEASE NOTE: QUOTE &amp; ACCESSORY CODE IS REQUIRED WITH REQUEST.</b>	
		<b>SUPPLIER/BRAND</b> Medifab/Quickie	
<b>SUPPLIER PRODUCT ID</b> 1567-00	<b>ENZ LIST CODE</b> ENZA248	<b>SIZE (width x depth)</b> 14-20x16-20	<b>ACC SIC CODE</b> EM152
1567-01	ENZA259	14-20x18-22	EM155



# ACC Complex List Equipment

## Wheelchair & Seating

Wheelchair - Manual- Fully Configurable		Complex	
		<b>SPECIFICATIONS</b> Kushall Compact Attract Folding <ul style="list-style-type: none"> <li>• Seat height : Front 430-520mm</li> <li>• Seat height : Rear 400-490mm</li> <li>• 24" rear wheels</li> <li>• Total width - seat width + 18cm</li> <li>• Total width folded 30cm</li> <li>• Total length 70degree: 985mm, 90degree: 895mm, w/ out legrest: 690mm</li> </ul>	
		<b>PLEASE NOTE: QUOTE IS REQUIRED WITH REQUEST.</b>	
<b>SUPPLIER/BRAND</b> Invacare/Kushall		<b>MAX USER WEIGHT</b> 130kg	
SUPPLIER PRODUCT ID	ENZ LIST CODE	SIZE	ACC SIC CODE
COMPACT-ATT-BLK-A	ENZA227	16x16	EM127
COMPACT-ATT-BLK-B	ENZA228	16x18	EM127
COMPACT-ATT-BLK-C	ENZA229	18x18	EM127
COMPACT-ATT-BLK-D	ENZA230	18x20	EM127
COMPACT-ATT-BLK-E	ENZA231	20x20	EM127
COMPACT-ATT-BLK-F	ENZA232	18x16	EM127
COMPACT-ATT-BLK-G	ENZA233	14x16	EM127
COMPACT-ATT-BLK-H	ENZA234	20x18	EM127

# ACC Complex List Equipment

## Wheelchair & Seating

Wheelchair- Fully Configurable		Complex	
		<b>SPECIFICATIONS</b>	
		<p>TiLite AeroX Folding</p> <p><b>Base unit includes:</b></p> <p><b>AeroX</b></p> <ul style="list-style-type: none"> <li>• Swingaway Legrests 85 deg standard, also available in 70, 80 and 90 deg, as well as fixed front end</li> <li>• Composite Flip Up Footplates height adjustable</li> <li>• Composite Casters either 4, 5, or 6"</li> <li>• Composite Push or Pull 2 Lock Brakes</li> <li>• Seat upholstery and padded backrest upholstery adjustable slide in seat sling</li> <li>• Height Adjustable Fixed Angle Back Canes 90 deg or with 8 deg bend</li> <li>• Integrated Push Handles</li> <li>• TiLite Shadow Rear Wheel 22", 24", 25" or 26"</li> <li>• Silver Anodized Handrim</li> <li>• Tyre Treaded or Smooth</li> <li>• TiLite Stainless Quick Release Axles</li> <li>• Camber 0, 2, 4, 6 deg</li> <li>• Fully adjustable seat-to-floor heights and centre of gravity</li> <li>• Colour red, blue, black or silver</li> </ul> <p><b>Accessories:</b>  <b>ENZ LIST CODE:</b> ENZA8  <b>ACC SIC CODE:</b> EM135A</p> <p><a href="#">Click here for script form</a></p> <p><b>PLEASE NOTE: QUOTE &amp; ACCESSORY CODE IS REQUIRED WITH REQUEST.</b></p>	
<b>SUPPLIER/BRAND</b>		<b>MAX USER WEIGHT</b>	
Permobil/TiLite		120kg standard and 159kg heavy duty	
<b>SUPPLIER PRODUCT ID</b>	<b>ENZ LIST CODE</b>	<b>SIZE (width x depth)</b>	<b>ACC SIC CODE</b>
AXFS1	ENZA226	12-22x12-20	<b>EM135</b>

# ACC Complex List Equipment

## Wheelchair & Seating

Wheelchair Fully Configurable		Complex	
		<b>SPECIFICATIONS</b>  Quickie 2 Folding  <b>Base unit includes:</b>  <b>Quickie 2</b> <ul style="list-style-type: none"> <li>• DAB depth &amp; angle adjustable backrest</li> <li>• 24" lite spoke rear wheels</li> <li>• Anodised push rims</li> <li>• Marathon plus tyres</li> <li>• 5" x 1.5" semi-pneumatic castors</li> <li>• Single post height adjustable armrests with full length-pads</li> <li>• 80 degree swingaway footrest hangers</li> <li>• Aluminium angle adjustable footplates</li> <li>• 16" high 3DX tension adjustable back upholstery</li> <li>• Integrated push handles</li> <li>• Anti-tips</li> <li>• Colour is black opal</li> </ul>	
		<b>Accessories:</b> <b>ENZ LIST CODE:</b> ENZA3 <b>ACC SIC CODE:</b> EM153A  <a href="#">Click here for script form</a>  <b>PLEASE NOTE: QUOTE &amp; ACCESSORY CODE IS REQUIRED WITH REQUEST.</b>	
<b>SUPPLIER/BRAND</b>		<b>MAX USER WEIGHT</b>	
Medifab/Quickie		136kg standard and 158kg heavy duty	
<b>SUPPLIER PRODUCT ID</b>	<b>ENZ LIST CODE</b>	<b>SIZE (width x depth)</b>	<b>ACC SIC CODE</b>
1571	ENZA238	12-19x12-19	<b>EM150</b>
1571	ENZA240	12-19x20 & 20x12-19	<b>EM153</b>
1571-2020-001	ENZA250	20x20	<b>EM154</b>

# ACC Complex List Equipment

## Wheelchair & Seating

Wheelchair Rigid - Z Style		Complex	
		<b>SPECIFICATIONS</b>	
		<p>TiLite ZRA Rigid</p> <p><b>Base unit includes:</b></p> <p><b>ZRA</b></p> <ul style="list-style-type: none"> <li>• Front Frame Angle 85 deg standard, also available in 70, 80 and 90 deg, as well as fixed front end</li> <li>• Footrest Width Taper no taper, 1.5" or 3.5"</li> <li>• Angle Adjustable Footplate height adjustable</li> <li>• Composite Casters 4, 5, or 6"</li> <li>• Composite Push or Pull 2 Lock Brakes</li> <li>• Bolt-On Tension Adj. Seat Upholstery</li> <li>• Padded Backrest Upholstery</li> <li>• Height/Angle adjustable Folding Backrest</li> <li>• Aluminium Back Release Bar</li> <li>• Integrated Push Handles</li> <li>• Aluminium Camber Tube 0, 2, 4, 6 Deg Camber</li> <li>• TiLite Shadow Rear Wheel 20", 22", 24", 25" or 26"</li> <li>• Silver Anodized Handrim</li> <li>• Tyre Treaded or Smooth</li> <li>• TiLite Stainless Quick Release Axles</li> <li>• Camber 0, 2, 4 or 6 deg</li> <li>• Fully adjustable seat-to-floor heights and centre of gravity</li> <li>• Colour red, blue, black or titanium satin"</li> </ul> <p><b>Accessories:</b>  <b>ENZ LIST CODE:</b> ENZA7  <b>ACC SIC CODE:</b> EM133A</p> <p><a href="#">Click here for script form</a></p> <p><b>PLEASE NOTE: QUOTE &amp; ACCESSORY CODE IS REQUIRED WITH REQUEST.</b></p>	
<b>SUPPLIER/BRAND</b>		<b>MAX USER WEIGHT</b>	
Permobil/TiLite		120kg standard and 136kg Heavy Duty	
<b>SUPPLIER PRODUCT ID</b>	<b>ENZ LIST CODE</b>	<b>SIZE (width x depth)</b>	<b>ACC SIC CODE</b>
Z2FS2	ENZA249	10-20x10-20	EM133

# ACC Complex List Equipment

## Wheelchair & Seating

Wheelchair Rigid - Z Style				Complex	
		<b>SPECIFICATIONS</b>			
		<p>Hawk Rigid</p> <p><b>Base unit includes:</b></p> <p><b>Hawk Aluminium</b>                      Frame sizes: 16-20x16-20 in inch increments</p> <ul style="list-style-type: none"> <li>• Fixed front</li> <li>• 4,5 or 6" castor, narrow or wide with plastic hub</li> <li>• Push to lock brakes</li> <li>• Anti-tips</li> <li>• Standard wheel sizes 24 to 26"</li> <li>• Standard Sling and Tension adjustable back upholstery</li> <li>• Leg strap</li> <li>• Impact guards</li> <li>• Colour Red, blue, black or silver</li> </ul> <p><b>Hawk Titanium</b>                      Frame sizes: 16-20x16-20 in inch increments</p> <ul style="list-style-type: none"> <li>• Fixed front</li> <li>• 4,5 or 6" castor, narrow or wide with plastic hub</li> <li>• Push to lock brakes</li> <li>• Anti-tips</li> <li>• Standard wheel sizes 24 to 26"</li> <li>• Standard Sling and Tension adjustable back upholstery</li> <li>• Leg strap</li> <li>• Impact gaurds</li> <li>• Colour standard titanium finish</li> </ul> <p><b>Accessories: Aluminium</b>  <b>ENZ LIST CODE:</b> ENZA10  <b>ACC SIC CODE:</b> EM140A</p> <p><b>Accessories: Titanium</b>  <b>ENZ LIST CODE:</b> ENZA11  <b>ACC SIC CODE:</b> EM141A</p> <p><a href="#">Click here for script form</a></p> <p><b>PLEASE NOTE: QUOTE &amp; ACCESSORY CODE IS REQUIRED WITH REQUEST.</b></p>			
<b>SUPPLIER/BRAND</b>		<b>MAX USER WEIGHT</b>			
Melrose Kiwi Concept Chairs/Hawk		100kg			
SUPPLIER PRODUCT ID	ENZ LIST CODE	OPTIONS	SIZE	ACC SIC CODE	
90420A	ENZA247	Aluminium	16-20x16-20	<b>EM140</b>	
90420	ENZA266	Titanium	16-20x16-20	<b>EM141</b>	

# ACC Complex List Equipment

## Wheelchair & Seating

Wheelchair Rigid - Rigid Z Style		Complex	
		<b>SPECIFICATIONS</b>  Ki Rogue Rigid  <b>Base unit includes:</b>  <b>Ki Rogue</b> Frame sizes: 12-19x14-19 <ul style="list-style-type: none"> <li>• Tubular open footplate</li> <li>• Selection of 70,75,80 or 85</li> <li>• 3,4,5 or 6" x 1 poly castor</li> <li>• Standard seat upholstery and padded backrest upholstery</li> <li>• Height adjust back canes</li> <li>• 20, 22, 24, 25, 26 standard spoke wheels and</li> <li>• Aluminum anodised pushrims, street pneumatic tyre-sand quick release axles</li> <li>• Brake options push to lock, push to lock flush mountor pull to lock</li> <li>• 0,2,4,6, or 8 deg camber</li> </ul>	
		<b>Accessories:</b> <b>ENZ LIST CODE:</b> ENZA12 <b>ACC SIC CODE:</b> EM142A  <a href="#">Click here for script form</a>  <b>PLEASE NOTE: QUOTE &amp; ACCESSORY CODE IS REQUIRED WITH REQUEST.</b>	
<b>SUPPLIER/BRAND</b>		<b>MAX USER WEIGHT</b>	
Allied Medical/ Ki		100kg	
<b>SUPPLIER PRODUCT ID</b>	<b>ENZ LIST CODE</b>	<b>SIZE (width x depth)</b>	<b>ACC SIC CODE</b>
KIROGUEXXXXXX	ENZA236	12-19x14-19	<b>EM142</b>



# ACC Complex List Equipment

## Wheelchair & Seating

Wheelchair - Rigid Z Style		Complex	
		<b>SPECIFICATIONS</b>	
		<p>APEX Aluminium Rigid</p> <ul style="list-style-type: none"> <li>• Wheel Size 20", 26"</li> <li>• AluLite Aluminium alloy Frame – Stronger and lighter than 7005 Aluminium</li> <li>• Fixed Largest – 80 deg Standard – also available in 90, 85, 75 and 70 deg</li> <li>• 1" Front frame taper Std but available with no taper</li> <li>• Adjustable Aluminium Angle Footplate</li> <li>• Aluminium Soft Roll Casters 5" std, also available in 4' and 6"</li> <li>• Push to Lock brakes – Composite – Also available in Pull to lock or Scissors brake</li> <li>• Seat upholstery</li> <li>• Tension Adjustable Back upholstery</li> <li>• Height and angle Adjustable folding back canes</li> <li>• Push handles</li> <li>• Newton Gravity Ultra light Rear Wheels</li> <li>• Aluminium Anodized push rims</li> <li>• HP tyre</li> <li>• Quick release axels</li> <li>• 4 deg Camber – Also available in 2, 6 and 8 Deg</li> <li>• Std colour option</li> <li>• Ultra Light carbon Fibre camber bar</li> <li>• Fully Adjustable Front and Rear Sea to to Floor heights (rear 14" to 20"/ Front 14" to 21")</li> <li>• 6" Centre of Gravity Adjustment</li> <li>• Weight Limit 120kg</li> <li>• Built in bubble levels for accurate caster adjustments</li> </ul> <p><b>Accessories:</b>  <b>ENZ LIST CODE:</b> ENZA13  <b>ACC SIC CODE:</b> EM146A</p> <p><a href="#">Click here for script form</a></p> <p><b>PLEASE NOTE: QUOTE &amp; ACCESSORY CODE IS REQUIRED WITH REQUEST.</b></p>	
<b>SUPPLIER/BRAND</b>		<b>MAX USER WEIGHT</b>	
Custom Tech/Apex		120kg	
<b>SUPPLIER PRODUCT ID</b>	<b>ENZ LIST CODE</b>	<b>SIZE (width x depth)</b>	<b>ACC SIC CODE</b>
APEXA	ENZA246	14x16-20x18	<b>EM146</b>

# ACC Complex List Equipment

## Wheelchair & Seating

Wheelchair Self - Rigid Z Style		Complex	
		<b>SPECIFICATIONS</b>	
		<p>TiLite AeroZ Rigid</p> <p><b>Base unit includes:</b></p> <ul style="list-style-type: none"> <li>• Front Frame Angle 85 deg standard, also available in 70, 80 and 90 deg, or custom angle</li> <li>• Footrest Width Taper no taper, 1.5" or 3.5"</li> <li>• Angle Adjustable Footplate height adjustable</li> <li>• Composite Casters 4, 5, or 6"</li> <li>• Composite Push or Pull 2 Lock Brakes</li> <li>• Bolt-On Tension Adj. Seat Upholstery</li> <li>• Padded Backrest Upholstery</li> <li>• Height/Angle adjustable Folding Backrest</li> <li>• Aluminium Back Release Bar</li> <li>• Integrated Push Handles</li> <li>• Aluminium Camber Tube 0, 2, 4, 6 Deg Camber</li> <li>• TiLite Shadow Rear Wheel 20", 22", 24", 25" or 26"</li> <li>• Silver Anodized Handrim</li> <li>• Tyre Treaded or Smooth</li> <li>• TiLite Stainless Quick Release Axles</li> <li>• Camber 0, 2, 4 or 6 deg</li> <li>• Fully adjustable seat-to-floor heights and centre of gravity</li> <li>• Colour red, blue, black or titanium grey</li> </ul> <p><b>Accessories:</b>  <b>ENZ LIST CODE:</b> ENZA9  <b>ACC SIC CODE:</b> EM137A</p> <p><a href="#">Click here for script form</a></p> <p><b>PLEASE NOTE: QUOTE &amp; ACCESSORY CODE IS REQUIRED WITH REQUEST.</b></p>	
<b>SUPPLIER/BRAND</b>		<b>MAX USER WEIGHT</b>	
Permobil/TiLite		120kg	
<b>SUPPLIER PRODUCT ID</b>	<b>ENZ LIST CODE</b>	<b>SIZE (width x depth)</b>	<b>ACC SIC CODE</b>
AZFS1	ENZA235	10-20"x10"-20"	EM137



# ACC Complex List Equipment

## Wheelchair & Seating

Power Wheelchair		Complex	
		<b>SPECIFICATIONS</b> Karma KP25 power chair Rear wheel drive  Standard Folding <ul style="list-style-type: none"> <li>• VR2 Electronics</li> <li>• 50-amp batteries</li> <li>• 70 degree swing away legrests</li> <li>• flip up - height adjustable armrests</li> <li>• Anti-tips</li> <li>• Battery charger</li> <li>• Floor to seat height 19" Min (21" available)</li> <li>• Overall width - seat width + 6.5"</li> </ul>	
		<b>SUPPLIER/BRAND</b> Allied Medical/Karma	
<b>SUPPLIER PRODUCT ID</b> KP251618L		<b>MAX USER WEIGHT</b> 135kg	
<b>ENZ LIST CODE</b> ENZA242		<b>ACC SIC CODE</b> EM103	
<b>SIZE (width x depth)</b> 16x18		<b>ACC SIC CODE</b> EM103	
<b>SIZE (width x depth)</b> 18x16		<b>ACC SIC CODE</b> EM103	
<b>SIZE (width x depth)</b> 16x16		<b>ACC SIC CODE</b> EM103	
<b>SIZE (width x depth)</b> 18x18		<b>ACC SIC CODE</b> EM103	

# ACC Complex List Equipment

## Wheelchair & Seating

Power Wheelchair				Complex	
			<b>SPECIFICATIONS</b> Quantum Edge 3 Power wheelchair Mid wheel drive		
			<ul style="list-style-type: none"> <li>• Q-Logic 3 expandable electronics</li> <li>• Smooth ride suspension (SRS)</li> <li>• 2 pole motors</li> <li>• Seat to floor height min 16.5"</li> <li>• Overall width 24.4"</li> <li>• Overall length (excluding footplates) 32.23"</li> <li>• 12-24"x12-24"</li> </ul> Accessory Code: <b>ENZ LIST CODE:</b> ENZA4 <b>ACC SIC CODE:</b> EM104A  <a href="#">Click here for script form</a>  PLEASE NOTE: QUOTE & ACCESSORY CODE IS REQUIRED WITH REQUEST.		
<b>SUPPLIER/BRAND</b>			<b>MAX USER WEIGHT</b>		
Allied Medical/Edge			136kg		
SUPPLIER PRODUCT ID	ENZ LIST CODE	DESCRIPTION	SIZE	ACC SIC CODE	
PKBASEEDGE3T	ENZA1017	TILT READY BASE ONLY	12-24x12-24	EM104	
PKBASEEDGE3R	ENZA4018	REAC READY BASE ONLY	12-24x12-24	EM104	

Power Wheelchair				Complex	
			<b>SPECIFICATIONS</b> TDXSP2 Mid Wheel Drive		
			<ul style="list-style-type: none"> <li>• Linux expanadable electronics</li> <li>• Drive wheel 14"</li> <li>• 4 Pole Motor</li> <li>• Base length: 35.5"</li> <li>• Base width 24",25.5"</li> </ul> Accessory Codes : <b>ENZ LIST CODE:</b> ENZA5 <b>ACC SIC CODE:</b> EM120A  PLEASE NOTE: QUOTE & ACCESSORY CODE IS REQUIRED WITH REQUEST.		
<b>SUPPLIER/BRAND</b>			<b>MAX USER WEIGHT</b>		
Invacare/TDXSP2			136kg		
SUPPLIER PRODUCT ID	ENZ LIST CODE	SIZE (width x depth)	ACC SIC CODE		
TDXSP2-BASE-ANZ	ENZA267	12-22x12-24"	EM120		

# ACC Complex List Equipment

## Wheelchair & Seating

Power Wheelchair		Complex	
		<b>SPECIFICATIONS</b> TAIQMWD Mid Wheel Drive <ul style="list-style-type: none"> <li>• RNET expandable electronics</li> <li>• Drive wheel size 35cm/14"</li> <li>• Castor wheel size 20cm/8"</li> <li>• Floor to seat height min 38-43cm/15-17"</li> <li>• Floor to seat height max 68-73cm/27-29"</li> <li>• Overall width 60-63cm/23.5-25"</li> <li>• Overall length without footrests 91cm/36"</li> </ul>	
		<b>Accessory Codes:</b> <b>ENZ LIST CODE:</b> ENZA6 <b>ACC SIC CODE:</b> EM122A  <b>PLEASE NOTE: QUOTE &amp; ACCESSORY CODE IS REQUIRED WITH REQUEST.</b>	
<b>SUPPLIER/BRAND</b>		<b>MAX USER WEIGHT</b>	
Morton & Perry/TAIQ		140kg	
<b>SUPPLIER PRODUCT ID</b>	<b>ENZ LIST CODE</b>	<b>SEAT SIZE (width x depth)</b>	<b>ACC SIC CODE</b>
XTAIQMWD02	ENZA269	37-55x35-55cm	<b>EM122</b>